

# Engineering Safety Inspections of Cable Log Yarders Best Practice Guidelines



# Foreword

The forestry industry can be a high-risk sector.

Helping to keep the industry as safe as possible for all those involved is the main aim of these best practice guidelines. They form part of a series of best practice guidelines developed by the industry.

These guidelines combine industry training standards and best practice information to provide a reference manual for yarder owners and inspectors.

They add to the provisions of the Approved Code of Practice for Safety and Health in Forest Operations.

Along with other documents, the guidelines will directly assist those who have responsibilities under the Health and Safety at Work Act 2015 in managing hazards and associated risks in the forestry work environment.

First edition September 2002

Revised edition September 2005

FICA/CBIP/FISC edition June 2022

These Best Practice Guidelines are to be used as a guide to engineering safety inspections of cable yarders. They do not supersede legislation in any jurisdiction or the recommendations of equipment manufacturers.

FICA/CBIP/FISC believes that the information in the guideline is accurate and reliable; however, FICA/CBIP/FISC notes that conditions vary greatly from one geographical area to another; that a greater variety of equipment and techniques are currently in use; and other (or additional) measures may be appropriate in each situation.

## Acknowledgments

FICA/CBIP/FISC acknowledges the assistance of the New Zealand Forest Owners Association (Tower Inspection Working Group), Brightwater Forest Equipment, Work Smart Forestry, and numerous forest industry trainers, forestry contractors, and forest company staff in the development of these Best Practice Guidelines.

©Copyright 2022, FICA/CBIP/FISC, New Zealand



**FOREST INDUSTRY  
CONTRACTORS  
ASSOCIATION**

# Contents

<b>Foreword</b>	<b>2</b>
<b>Introduction</b>	<b>6</b>
– Purpose of these guidelines	
– How to use these guidelines	
– Terminology	
<b>Part A - Principles of engineering safety inspections of cable yarders</b>	
<b>Safety Inspections</b>	<b>9</b>
– Purpose of engineering safety inspections	
– Yarder tower collapses	
– Checking integrity of the tower and key operating components	
– Frequency of inspections	
– Repairs and modifications arising from inspections	
<b>Basic strength of materials</b>	<b>14</b>
<b>Stress-strain relationship</b>	<b>14</b>
– Types of Stress	
– Strength Properties	
<b>Fatigue</b>	<b>15</b>
– Fatigue Failures	
– Fatigue Strength	
– Endurance Limit	
<b>Types of failure</b>	<b>17</b>
<b>Risk indications</b>	<b>17</b>
<b>Repairs to yarders</b>	<b>18</b>
– Minor Repairs	
– Major Repairs	
– Seeking Expert Advice	
<b>Modifications to yarder towers</b>	<b>19</b>
– Unacceptable modifications	

<b>Training requirements</b>	<b>19</b>
<b>Risk management</b>	<b>20</b>
<b>Health risks</b>	<b>21</b>
– Personal protective equipment (PPE)	
<b>Operational risks</b>	<b>22</b>
<b>Safetree cards</b>	<b>22</b>
<b>Personal protective equipment (PPE)</b>	<b>28</b>

## **Part B - Engineering safety inspection procedures**

<b>Planning the inspection</b>	<b>30</b>
– Arranging access	
– Presentation of the yarder	
– Equipment and documentation requirements	
<b>Inspecting yarders</b>	<b>31</b>
– Skyline sheave	
– Tower (spar)	
– Guywinch	
– Tower (spar) mounting frame	
– Tower (spar) transport frame	
– Inspecting swing yarders	
– Gantry frames	
– Side rollers (tower and gantry)	
– Slew ring and car body attachment	
<b>Machine guarding</b>	<b>51</b>
– Commonly encountered machine guarding hazards and associated risks on cable log yarders and their possible solution.	
<b>Safe Access</b>	<b>54</b>
<b>Mechanical and Control</b>	<b>56</b>
<b>Operator Protective Structures (OPS)</b>	<b>58</b>
<b>Inspection Elements</b>	<b>60</b>

- Identification/Certification Data Plate (Tag)
- Invalid Certification Data Plates
- Duration of Certification
- Condition Assessment - OPS
- Condition Assessment - FOPS
- Repairs and Modifications
- Reporting OPS Compliance

---

## Wire Ropes 63

---

### Maximum Replacement Intervals 63

---

### Rope Condition Assessment 63

- Some Causes of Wire Rope Failure
- Discard Criteria

## Part C - Record keeping and reporting

---

### Glossary of terms 69

---

### Appendix A 71

- Yarder machine guarding issues and examples (courtesy WorkSafe NZ)

---

### Appendix B - Certified Inspection Plate 78

---

### Appendix C - OPS Compliance Reporting Form 79

---

### Appendix D 88

- Major inspection of tubular towers (spars)

---

### Appendix E - Yarder Tower FICA APP User Guide 90

# Introduction

## Purpose of these guidelines

The Best Practice Guidelines for Engineering Safety Inspections of Cable Yarders have been designed to improve the safety of workers on yarder landings. The guidelines combine industry training standards and best practice information to provide a valuable reference manual for yarder owners and inspectors.

These guidelines provide direct reference to integral/fixed, pivoted/leaning and free-standing towers and also swing yarders. Many of the principles and procedures presented are applicable to alternative yarder systems, such as excavator-based yarders and independent spar yarders.

**Kia tipu te Tohungatanga i roto i o matou mahi ngahere katoa**  
**“That the highest order of professionalism be nurtured**  
**with all our work in the forests”**

## How to use these guidelines

These guidelines have been arranged in three main sections:

- Principles of engineering safety inspections of cable yarders provides an overview of the strength characteristics of materials, repair and maintenance requirements, and health and safety issues associated with completing inspections.
- Engineering safety inspection procedures provides a detailed description of the best practice for carrying out yarder inspections. This section provides a step-by-step approach to completing the inspection.
- Example inspection forms are presented to provide a framework for operational checklists and documentation.

The **Glossary of Terms** gives the meaning of terms used throughout these guidelines.

## Terminology

The term “yarder” refers to integral and free-standing tower and swing yarders.

# Part A

## Principles of engineering safety inspections of cable yarders







# Safety Inspections

## Purpose of engineering safety inspections

The collapse of a yarder tower during set-up and operation poses a significant hazard for the yarder operator, skid workers, and breaker-outs. If a working rope should fail during operation, the tower should remain standing.

However, this may not be the case where:

- The guylines and/or anchors are poorly configured and/or of inadequate strength
- The structural integrity of the tower or other safety-critical component has been weakened through wear, damage, or inappropriate repairs and modifications

## Yarder tower collapses

Operational procedures contribute to the greatest proportion of yarder tower collapses. Damaged or defective tower components do contribute to tower collapses, the most common being the sudden telescoping down of the tower during yarder set-up or operation.

## Checking integrity of the tower and key operating components

The purpose of an engineering safety inspection is to check the integrity of the tower and key operating components. This is a formal, systematic process to be performed by experts, similar to the warrant of fitness required for vehicles and certifications required for other safety-critical plant such as cranes.

The routine engineering safety inspection is just one means of managing potential hazards associated with yarder tower collapse and general operation of the yarder. It is not a replacement for safe operation of the yarder on a day-to-day basis.

For further information on yarder rigging and operation refer to the **Best Practice Guidelines for Cable Logging**.

## Frequency of inspections

Inspections shall be performed:

- On the commissioning (new) date and then annually thereafter
- Before a newly imported second-hand yarder starts work
- Before commencing work where a machine has been idle and the engineering safety inspection certificate has expired
- After an accident involving or damage to the tower, tower supporting devices or any other equipment on the yarder covered by these guidelines.

After the initial inspection, subsequent inspections are repeated annually. To ensure that the yarder has a current engineering safety certificate at all times, the repeat inspections should be scheduled to allow any repairs to be made before the previous certificate expires.

## Repairs and modifications arising from inspections

Repairs and modifications shall be identified as **Major, Minor and Maintenance**:

- **Major work** is to be completed and approved by the yarder engineering safety inspector before the yarder is returned to service, at which point a full-term Certificate of Inspection may be issued
- **Minor work** is to be completed within one month. A Certificate of Inspection for this one-month duration shall be issued. Once the Minor work has been completed and approved by the yarder engineering safety inspector, a full-term Certificate of Inspection may be issued. Otherwise, the (interim) Certificate will be deemed to have lapsed.
- **Maintenance work** is to be completed and approved by/at the next annual inspection.

## Yarder tower components

The main yarder tower components for tower and swing yarders are shown below.



A Guyblocks

B Guyblock Mount

C Skyline

D Tail Rope

E Main Rope

F Locking Dogs



A Stawline  
Fair-Lead

B Tower Razing  
Ram

C Tower Cradle

D Stabilizer Ram

E Ground  
Stabilizer Ram

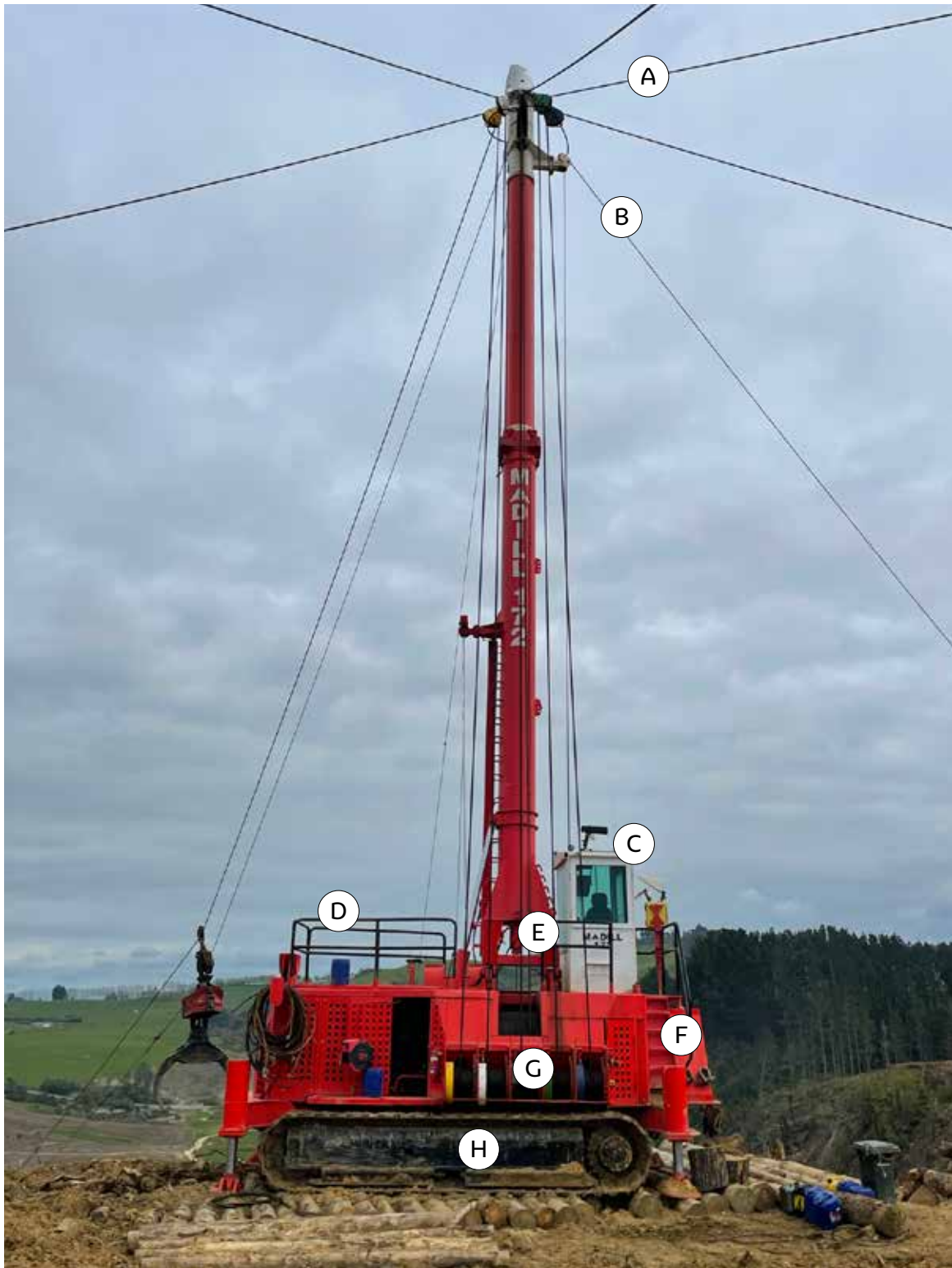

- |   |                          |   |               |   |                |   |             |
|---|--------------------------|---|---------------|---|----------------|---|-------------|
| A | Guy Ropes                | B | Tag Line      | C | Hauler Cab     | D | Hand Rails  |
| E | Tower<br>Telescoping Ram | F | Access Stairs | G | Guy Rope Drums | H | Track Frame |

## Basic strength of materials

### Stress-strain relationship

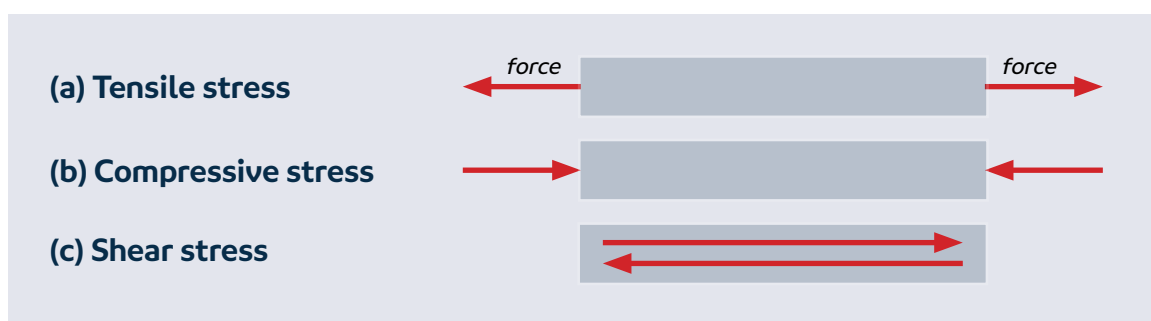

Three main type of stress

### Types of Stress

Stress is defined as the unit force per unit area. It is often expressed as newtons per metre squared (or pounds per square inch). There are three main types of stress:

- Tensile stress – where the stress tends to stretch a material
- Compressive stress – where the stress tends to shorten or compress a material
- Shear stress – where the stress tends to shear a material (*see above*)

Strain relates to the amount of dimensional change when a material is subjected to a stress.

Metals (and other solid materials) react to stress in different ways according to their strength properties (yield strength and ultimate strength).

### Strength Properties

The **Yield Strength** relates to the stress at which a metal permanently deforms after the stress has been released. This occurs above the elastic limit. Below this, the material recovers to its original dimensions with no adverse effects.

The **Ultimate Strength** of a metal corresponds to the stress at which the material fails. Applied stresses that exceed the yield strength result in permanent deformation. The greater the stress and/or the greater the number of stress applications, the more severe the permanent deformation. This also results in a reduction in the ultimate strength. This is significant for yarder tower structures that are subjected to high degrees of cyclic loading.

# Fatigue

## Fatigue Failures

Fatigue failures are potentially dangerous because they occur without warning and at a stress much lower than the ultimate stress for the material.

Such failures are most commonly associated with shafts and other rotating components, but any equipment subjected to cyclic loading is susceptible.

A fatigue failure usually has its origin in some surface imperfections (sometimes an imperfection below the surface can be the cause). These imperfections can be due to:

- Manufacturing methods
- Heat treatment
- Handling
- Residual stresses and surface coatings
- Surface finish
- Environment
- Raw material production

Failure begins with the development of a small surface crack, at right angles to the direction of the tensile stress (fatigue does not occur where components are only ever loaded in compression).

Because the load is alternating, the crack is continually opened and closed; this motion causes the adjacent faces to rub against one another, making these surfaces both smooth and polished in appearance.

The remaining intact material is finally reduced to such a small area that it can no longer withstand the load and so it suddenly breaks. The final area appears as a grey, granular structure conveying the **false** impression that a brittle fracture has taken place (the “crystallised” fracture of engineering legend).

## Fatigue Strength

The **Fatigue Strength** of a component is the maximum “completely reversed” (i.e., cycled back and forth) stress at which the component will fail after it has experienced this loading **for a specified number of cycles**.

## Endurance Limit

The **Endurance Limit** is the maximum, completely reversed stress for which it is assumed a material will “never” fail, regardless of the number of stress cycles. It is generally accepted that ferrous (iron and steel) components that survive 10 million cycles of stress reversals will have an infinite life. Non-ferrous materials such as brass, copper, copper alloys, aluminium, and magnesium do not have an endurance limit (i.e., they will eventually fail due to fatigue).

When considering the likelihood of fatigue failure of any structural steel component of a yarder tower or other safety-critical component it is important to understand how the component is loaded during operation:

- Components that are loaded only in compression will not fail due to fatigue
- Components loaded cyclically in tension are at some risk of fatigue failure
- Components alternately compressed and then tensioned repeatedly are very vulnerable to fatigue failure.

Examples of components subject to fatigue		
Fatigue failure risk	Component	Nature of loading
Low	Free-standing tower base connections	Fluctuating compression
Medium	Guyline to tower attachment	Fluctuating tension
High	Leaning tower base connections	Fluctuating tensile and compressive loads when the yarder is operating at the extremes of its yarding radius. As the load varies on the working lines, the tower hinges are subject to loading alternately in the direction of the working lines and then (to a lesser extent) the opposite direction as the working lines surge and relax.

Any nicks, cuts, welds, drilled holes, or other “shape modifications” to components which are subject to fatigue loadings, can have the effect of concentrating stresses in the component and decreasing the time before the component fails.

If there is any suspicion that such components are damaged or modified, or that a crack is being initiated, then competent engineering advice must be sought.



## Types of failure

In the context of yarders, metal can fail through a combination of stretching, compressing, or shearing. These modes of failure occur at the molecular level in the metal. Visually, these failures are exhibited through deformation or cracking.

## Risk indications

Visual inspection of yarder tower and other safety-critical structures relies on being able to see deformation, wear, and cracking of the metal components.



*Failure started at the keyways where the transverse cracks grew to be so large that the remaining material could no longer sustain the load and the shaft finally broke. Note the shiny surface from the keyways to the break, which is granular in appearance.*

## Repairs to yarders

Structural repairs to a yarder may be classified as Major, Minor or Maintenance. This distinction is important as the class of repairs to be undertaken will dictate the repair and sign-off process that must be followed.

### Minor Repairs

A **Minor repair** is one that if not completed does not contribute directly to a machine failure. Examples of minor repairs are the removal and replacement of a single diagonal member in a swing yarder boom, repairs to a bent or cracked sheave side plate, or repairs to the strawline or tagline mounts.

### Major Repairs

Conversely, a **Major repair** is one that if not completed correctly may directly contribute to the failure of the tower. Examples of major repairs are repairs to a tubular tower, tower mounts, or guyblock mounts/lugs, tower stabiliser and lift ram connections, machine stabilisers etc. In the case of a swing yarder, repairs to the main tower chords, connections to the tower or gantry and the guyline fairleads.

### Seeking Expert Advice

Minor repairs must be completed in accordance with industry best-practice by experienced and qualified personnel. The repairer must supply a certificate to this effect.

A yarder engineering safety inspector may oversee and approve minor structural repairs providing he/she feels competent to do so.

The yarder engineering safety inspector should seek advice from a suitably experienced Chartered Professional Engineer (CPEng):

- Where a repair is beyond the competence of the yarder engineering safety inspector; or
- When a major structural or functional repair is to be undertaken.
- The CPEng will be either a mechanical or structural engineer holding a current Practising Certificate and should be familiar with the type of work to be undertaken.
- The CPEng will assess the repair and issue specifications and inspection requirements for the work in accordance with AS/NZS1554.1 and/or AS/NZS1554.6.
- Welding repairs will be undertaken by AS/NZS 2980-qualified welders. Approval of welding procedures and inspection may require a Certified Welding Inspection (CWI) at the discretion of the CPEng. All relevant details are to be recorded on the Inspection Report.
- On completion of the Major repair, the CPEng will issue a Certificate approving the repairs.

## Modifications to yarder towers

Acceptable modifications are those within the specification of the yarder as new. Where a modification is beyond this scope, a suitably experienced Chartered Professional Engineer (CPEng) is required to certify the modification.

### Unacceptable modifications

Examples of unacceptable modifications (requiring certification) are the addition of extra plating to strengthen a mount, the addition of extra sheaves, modification of the tower mounts, increasing the horsepower of the engine or changing driving clutches, brakes or gearing.

There should be evidence of modification kept with the yarder logbook. This is particularly important for certified modifications where the details need to be available for WorkSafe inspectors and the engineering safety inspector.

## Training requirements

Inspectors should be qualified in accordance with industry best-practice, by:

- Holding a National Certificate in Heavy Fabrication (Level 4), a National Certificate in Maintenance and Diagnostic (Level 4), or equivalent qualification, or
- Being a suitably experienced Chartered Professional Engineer (CPEng).

They should also hold the following Unit Standards:

- General Requirements (Unit 17769)
- Emergency First Aid (Units 6401 and 6402) or equivalent

# Risk management

You should be aware of risks that impact your wellbeing and health as well as your physical safety. Your work should be designed and planned to take these risks into account.

People carrying out engineering safety inspections must be aware of the risks they may be exposed to and the control measure they, or others, should make use of to manage those risks and reduce harm to themselves and others. When identifying appropriate control measures you must consider the 'hierarchy of controls' as described in the diagram below. It means you have to use 'higher order controls' before resorting to personal protective equipment. So for example having a tower lowered for inspection rather than exposing someone to the risk of working at height.

## Hierarchy of controls

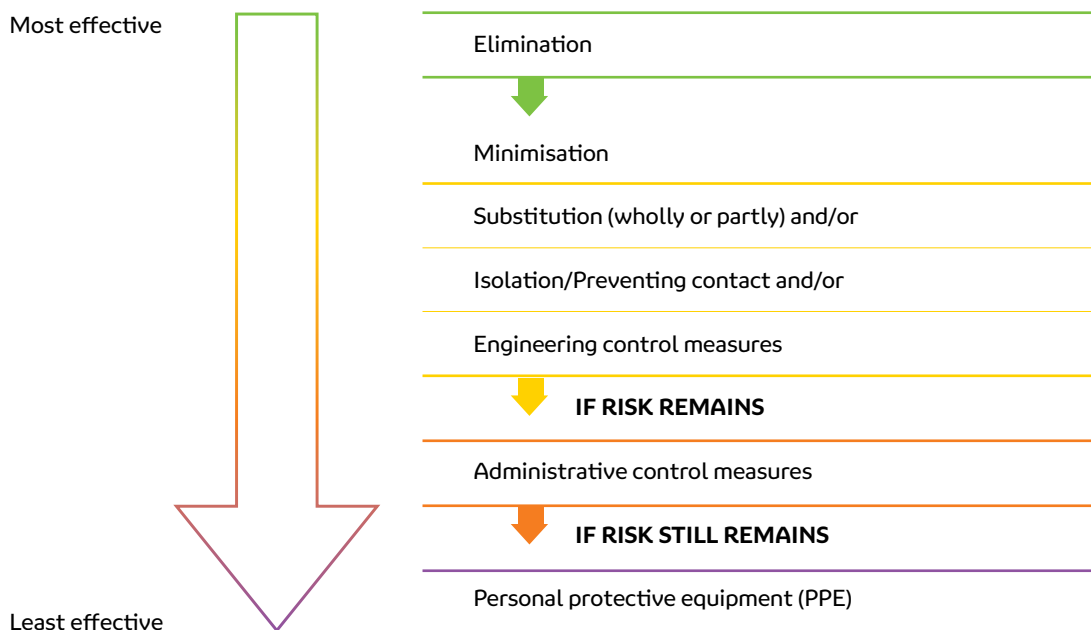

Inspections carried out on a work site within the forest are under the supervision of the contractor or representative for the site.

Before starting an inspection, those involved must formally discuss the planned work with those on site identify the risks associated with the work site and the tasks to be completed during the inspection. Once identified, appropriate control measures must be agreed and implemented. These can be documented in several ways.

The two main hazard categories are health hazards and operational hazards.

## Health risks

Individuals working in forestry operations need to be fit for the work they are doing both physically and mentally as this can impact them and others at the work site.

You should plan your workday to take these key factors into account:

- Travel to and from site
- Take adequate rest breaks
- Maintain an adequate level of hydration and diet
- Get adequate sleep
- Alcohol and other drugs
- Driving – to work, and at work
- Emergency response plan
- Fit for work
- Managing fatigue

## Personal protective equipment (PPE)

The Approved Code of Practice for Safety and Health in Forest Operations requires that people working in or visiting harvesting operations wear the following personal protective equipment:

- Hi-vis helmet
- Hi-vis shirt, vest, jacket or overalls
- Protective eyewear
- Hearing protection when noise levels exceed 85dB
- Safety footwear providing ankle support, lace-up type
- Other useful equipment:
- Gloves
- Small first-aid kit

Further information on PPE standards and care is provided in the **Best Practice Guidelines for Personal Protective Equipment.**

## Operational risks

Operational risks associated with engineering safety inspections of cable yarders relate to:

- Driving to and from work and on forestry roads
- General activities at the work site or landing
- The specific task of completing a tower inspection; working at height and entanglement
- Learning from incidents
- Managing visitor Safety
- Preventing slips and trips
- Protect your hearing
- Reducing stress on your body
- Working alone
- Working at height
- Working in bad weather
- Working in cold weather
- Working in hot weather

## Safetree cards

These cards provide guidance on key health and safety matters. They are available on the Safetree website and a full hardcopy pack can be provided to each inspector on request.

<https://safetree.nz/resources/tailgate-talking-topics-yarder-tower-inspectors/>

The cards provided cover:

- Fatigue
- How big is your waist?
- Reduce high blood pressure
- Stressed out



A copy of the Safetree Cards is provided [here](#) and are included below:

# Fatigue

01



- How's your fuel tank?
- Understand the signs of fatigue
- Take action to reduce fatigue

**Your fatigue is a danger to all of us. Speak up if you're fatigued.**



April 2020



# Fatigue



Being fatigued can make us more likely to have accidents and get injured. It also affects our mental health and ability to cope day to day.

**How's your fuel tank? Ask yourself...**

- Have you been awake for more than 17 hours? How much have you slept in the last 72 hours? Have you been told you snore or stop breathing in your sleep?
- Do you wake up refreshed? How often do you get up before 4am?
- How many caffeinated drinks do you have a day? Do you feel sleepy during the day, or fall asleep in moving vehicles?

**Understand the signs of fatigue – How are you feeling?**

- Do you feel:
- Sleepy, clumsy, slow to react, easily distracted, don't really know what's going on around you?
  - Headachy, dizzy, find it hard to speak or think clearly?
  - Feeling weak, easily angry or annoyed, can't remember things well, feel like you get sick a lot?

**In the red on the fuel gauge? Take action!**

- Get enough rest between shifts – aim for at least 7 hours' sleep, try to go to bed and get up about the same time each day even when you're not working, sleep in a dark, quiet, comfortable place.
- Get exercise, and lots of daylight, eat at regular times – but not just before bed – drink water to stay hydrated.
- Avoid caffeinated drinks, alcohol, nicotine, or use digital devices within two hours of going to bed.

**Understand your risk. Reassess in a month – has it improved?**

02

# Type 2 diabetes



- Know your risk for type 2 diabetes
- Change what you eat
- Change what you drink

**HbA<sub>1c</sub>** If person is not a known diabetic

**Eat more whole foods**  
Read nutritional panels on packaging

April 2020



# Type 2 diabetes



Diabetes can lead to serious health conditions, such as heart disease, nerve damage, blindness and kidney failure.

**Know your risk for type 2 diabetes**

- This means knowing your 'HbA<sub>1c</sub>' reading, which is how much glucose sticks to your red blood cells taken across a three month average.
- To find this out, see your GP for a blood test. If your reading is between 41 and 49 on the gauge, you are likely in the orange zone, which means you could be pre-diabetic. If your reading is over 50, you could be diabetic. Aim to have your blood sugar level in the green, so below 40.
- Measure your waist as it's a good indicator of general health – measurements considered healthy are for men's to be under 100cm, and women's under 86cm.

**If you are diabetic or pre-diabetic, get help from your doctor**

Here are some things we can all do to reduce our blood sugar levels.

**Change what you eat**

- Eat more whole foods and less processed food – for example buy a sandwich with salad instead of a pie.
- Avoid sugar – in processed foods, choose options with less than 10 grams of sugar per 100 grams.
- Eat more vegetables – have a variety of colours on your plate, including green leafy vegetables.

**Change what you drink**

- Water is the best drink.
- Avoid sweet drinks, which might give you a boost but make you feel tired later. These include natural fruit juice, fizzy drinks, energy and sports drinks, and alcohol.
- Also avoid artificially sweetened drinks.

**What's a sugar?**

Sugar can be called lots of names. On ingredients lists, look for things ending in 'ose', like sucrose, glucose, maltose, galactose, fructose.

**Understand your risk. Reassess in a month – has it improved?**



03

# How big is your waist?



- Measure your waist – take action if it’s too big
- Eat a variety of foods – avoid sugar, salt and too much fat
- Move as much as possible

April 2020

## Men

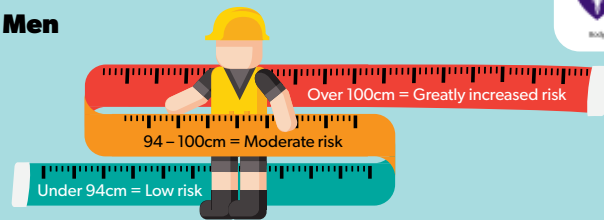

## Women

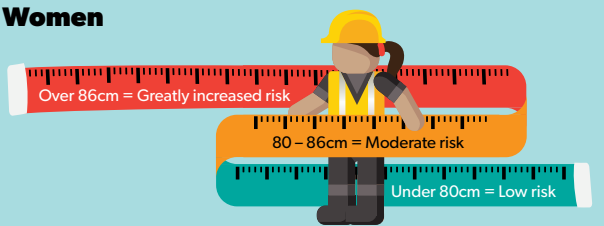

# How big is your waist?



The size of your waist is a good indication of your health. If it’s too big, you have a higher risk of developing conditions like heart disease, high blood pressure and diabetes.

**Measure your waist – then take action if you’re in the red or orange zones of the graph**

- Take a tape measure, breathe out, then measure around your waist halfway between your hipbone and ribs.
- Your health could be at risk if it measures more than 100cm for men, or 86cm for women.
- If it’s above that – and you’re in the orange or red zones of the graph – you should take action to reduce your waist size.

**Eat a variety of foods – avoid sugar, salt and too much fat**

- Eat lots of vegetables, with smaller serves of fruits and wholegrain carbohydrates, like brown rice and brown bread.
- Eat good-quality protein and healthy fats – so chicken, unprocessed red meat, fish, beans and lentils, nuts, olive oil, seeds and eggs.
- Avoid processed and sweet foods – like pies, chips, pizza, baking, fizzy and energy drinks.

**Move as much as possible**

- Be as active as you can at work – get out of the machine every two hours, walk on breaks, walk short distances to pick something up.
  - Play a sport – but take it slowly if it’s been a while.
  - Be active with your family – play with your kids, walk places instead of driving.
- How active should you be?** Do at least 2½ hours of moderate or 1¼ hours of hard physical activity spread over the week.

**Understand your risk. Reassess in a month – has it improved?**

## Reduce high blood pressure

04



KYNDWELLNESS.COM

- Know your blood pressure – measure and monitor regularly
- Reduce smoking, salt, stress
- Reduce the size of your waist

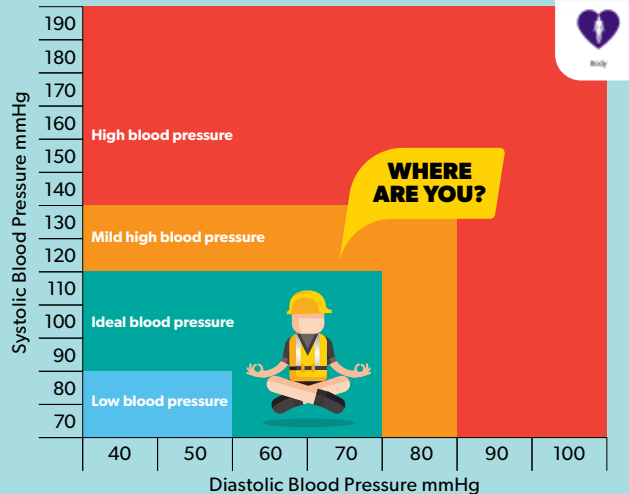

April 2020



## Reduce high blood pressure



KYNDWELLNESS.COM

People with unhealthy blood pressure readings have a higher chance of heart attack or stroke.

### Know your blood pressure – then measure and monitor regularly

- Know the symptoms of high blood pressure – headaches, fatigue, problems seeing, chest pain, difficulty breathing.
- Find out your blood pressure – get measured at the doctor's or a pharmacy.
- If your blood pressure is consistently '140 over 90' (140/90) or higher, you have high blood pressure.

### If you have high blood pressure, you will need help from your doctor.

Here are things we can all do to lower our blood pressure.

### Prioritise the three Ss:

- **Stop SMOKING** – Quitting can reduce blood pressure and bring other benefits, like more money and better health.
- **Eat less SALT** – eat less than 1 teaspoon of salt a day. Stop adding salt to food and read nutrition panels on packaged food, choosing foods with under 120 milligrams of sodium per 100 grams.
- **Manage STRESS** – try to change what is stressing you, or try not to be bothered by things you can't control. Get enough sleep and regular exercise. Keep connected to friends. Talk about what's stressing you. Text or call 1737 anytime to talk to someone.

### Reduce your waist size – if you measure over 100cm around the waist for men and 86cm for women, lose some weight.

- Extra fat means the heart must work harder to push blood around, which raises blood pressure.
- Change what you eat – choose more whole foods and less processed food, avoid saturated fat and sugar.
- Change what you drink – water is best, avoid sugary drinks and alcohol.

**Understand your risk. Reassess in a month – has it improved?**

05

# Stressed out

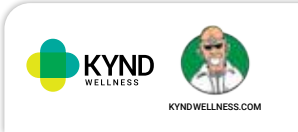

- Use a buddy system
- Manage your stress
- Know how to get support



April 2020



# Stressed out

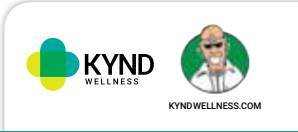

Life can be stressful, which can add up to us feeling pressured, angry, anxious, and even depressed.

**Use a buddy system**

- Check on each other – it’s OK to ask a mate how they’re doing if they don’t seem themselves.
- Check on yourself – have you had enough sleep? Are you hungry? Need exercise? What’s stressing you out?
- Keep your ‘emotional bank’ in credit – do what you enjoy as much as you can, which ideally is healthy and active.

**Manage your stress**

- Reduce stress long-term – try to change whatever is stressing you and let go of stressors you can’t control.
- Get enough sleep, regular exercise, and eat nutritious food – these are known to improve mental health.
- Make time to see people – strong connections help, so spend time with friends and family.

**Know how to get support**

- Tell your boss if you need some time to deal with whatever is going on.
- See your doctor or an employment assistance programme (EAP) to see how they can support you.
- Call or text 1737 to talk to a trained professional about anything stressing you out.

**Be understanding and supportive:** If a workmate or friend is stressed out, support them. Often we just need someone to talk to.

**Understand your risk. Reassess in a month – has it improved?**

## Personal protective equipment (PPE)

PPE is very much the last line of defence against risks and hazards, but is still an essential contributor to safe work in the forest.

The Approved Code of Practice for Safety and Health in Forest Operations requires that people working in or visiting harvesting operations wear the following personal protective equipment:

- Hi-vis safety helmet.
- Hi-vis shirt, vest, jacket or overalls.
- Protective eyewear, unless wearing it creates a greater risk.
- Hearing protection when noise levels exceed 85 dB. Note that the PCBU should be able to provide this information).
- Safety footwear providing ankle support, (lace-up type).
- Gloves (leather or thick cotton).
- Small first-aid kit.

# Part B

## Engineering safety inspection procedures



## Planning the inspection

### Arranging access

Before entering the forest to complete a yarder inspection, contact the contractor (or his/her agent) to specify an inspection time and location. Also, contact the forest owner to ascertain their entry requirements.

Most forest owners require visiting service providers to have obtained an access permit or access licence. This may involve submitting details about your company, vehicle, and the purpose of the visit. In some cases, the yarder engineering safety inspector (or employer) will have to submit an accepted Health and Safety Plan, carry specified safety equipment in the vehicle, and have access to specific road control radio channels.

### Presentation of the yarder

To perform a visual inspection, ensure that:

- The yarder is in a clean condition to allow any evidence of damage or wear to be seen
- The yarder is not being used operationally for the duration of the inspection
- The tower can be raised or lowered during the inspection to allow observation of the raising/ lowering mechanisms

During most of the inspection, the tower should be down to allow safe access to the tower and associated components.

## Equipment and documentation requirements

Before inspecting the yarder ensure you have the following equipment and documentation available:

### Equipment

- Personal protective equipment
- Spray paint
- Wire brush
- Camera (to document findings)
- Measuring tape
- Brake cleaning fluid
- Rope gauge
- Extension ladder
- Flash light
- Rags
- Binoculars (to observe operation of the tower when the tower is up)
- Approved fall arrest/work positioning harness if working in a position where a fall could cause injury

### Documentation

- Inspection forms or mobile device with appropriate software.
- Yarder logbook which specifically references the machine being inspected (including details and dates of repairs, modifications, maintenance, new ropes, and previous tower inspections). Note: absence of the logbook (or acceptable electronic alternative means that the yarder cannot be recertified until this documentation is produced and found to be acceptable.

## Inspecting yarders

The following section provides a step-by-step procedure for visually inspecting yarders. The components outlined are generic to both tower and swing yarders. Tower components specific to swing yarders are covered in the next section (Inspecting Swing Yarders).

The order in which the components are inspected will be based on personal preference and site practicalities.

## Skyline sheave

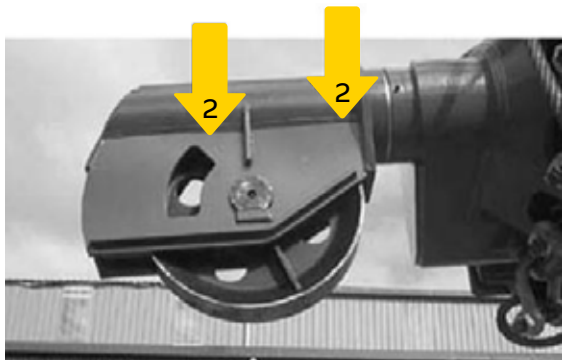

1. Visually check the alignment of the sheave with the tower. Check whether the sheave housing is bent away from its original angle. If so, the rope may be rubbing on the sides of the sheave pulley or on the sheave housing itself.
2. Check for cracks or damage where the cheek plates attach to the base plate and tube.

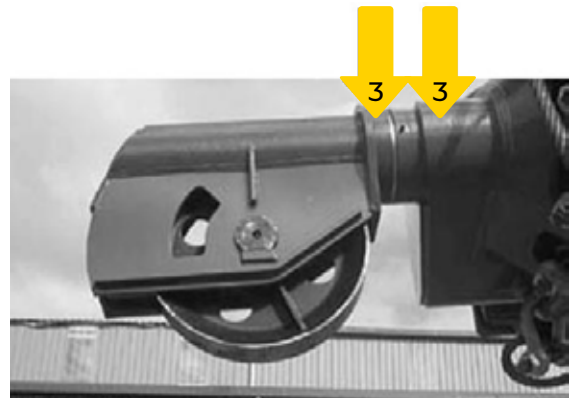

3. Check for cracks or damage around the pivot tube and pivot tube bosses, gussets, and mounting plates that attach them to the tower.

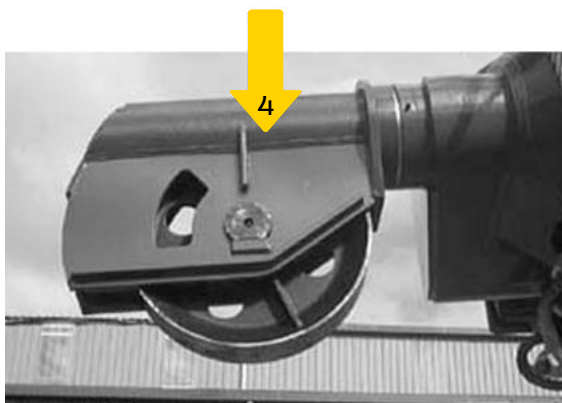

4. Check the back of the sheave housing for cracks.

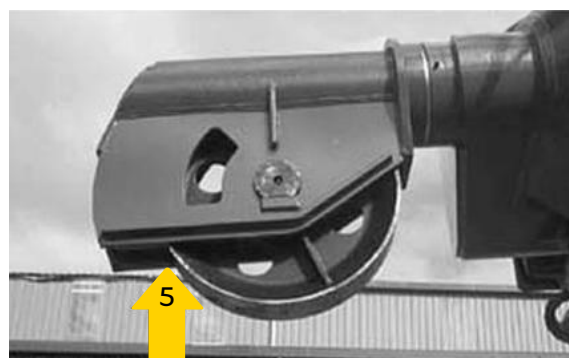

5. Check for damage to the front of the cheek plates (such as spreading).



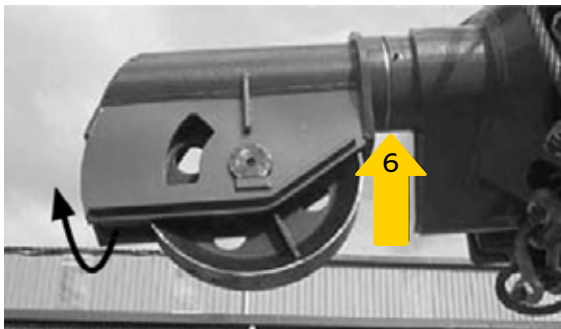

6. Check the condition of the pivot bushes or bearings. This does not mean dismantling them. Check for free play (with the use of a bar) and that the sheave rotates freely.

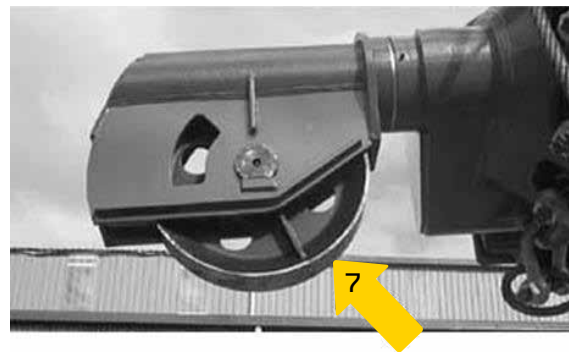

7. Check the condition of the sheave, looking for cracks, dents, rope marks, and the correct rope groove diameter for the rope ( $<\pm 5\%$  of each other).

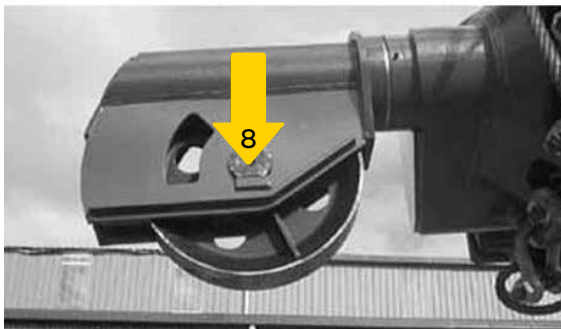

8. Check the condition of sheave bearings, bearing axle, locking nut, and washer. To check sheave bearings, rotate the sheave to see that it rotates freely. Then use a bar between the sheave and sheave housing side plate to see if there is free play in bearings.

## Mainline and haulback sheaves

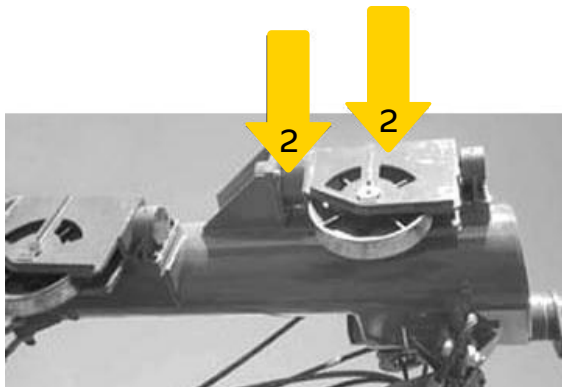

1. Visually check the alignment of the sheaves with the tower.
2. Check for cracks or damage where the cheek plates attach to the base plate and tube. For pedestal mounted sheaves, check for cracks and damage around the pivot tube, pivot tube bosses, gussets and mounting plates.

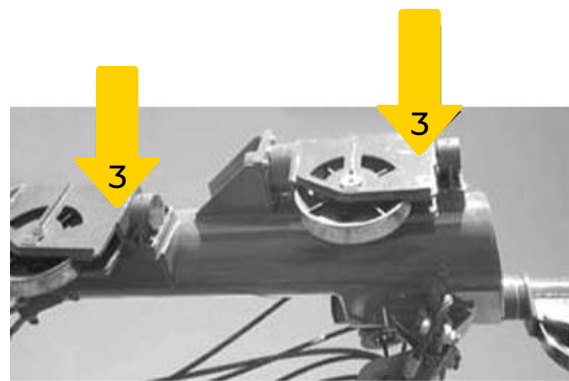

3. Check for cracks where the cheek plates join the top plate and pivot pin.

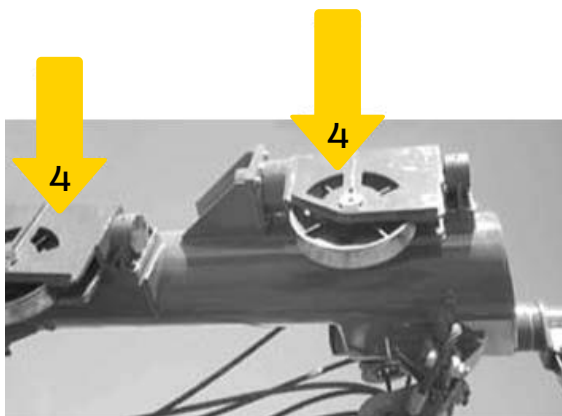

4. Check the back of the sheave housings for cracks.

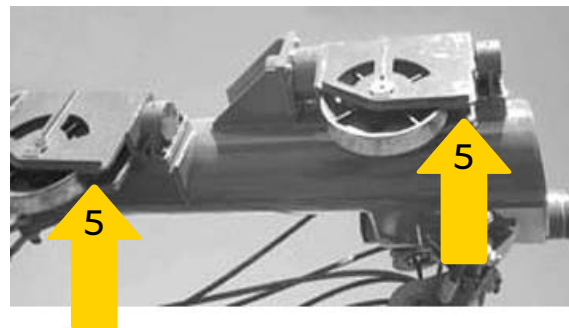

5. Check for damage to the front of the cheek plates (such as spreading).

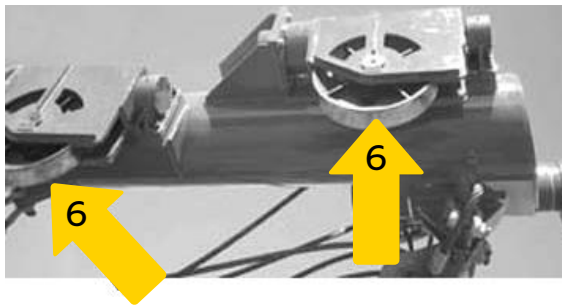

6. Check the condition of the sheave, looking for cracks, dents, rope marks, and the correct rope groove diameter for the rope ( $<\pm 5\%$  of each other).

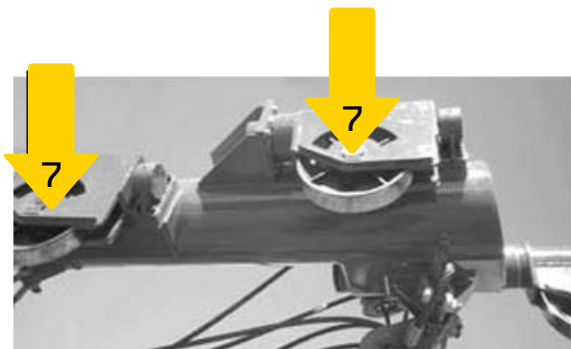

7. Check the condition of sheave bearings, bearing axle, locking nut, and washer.

## Strawline and tagline sheaves (where applicable)

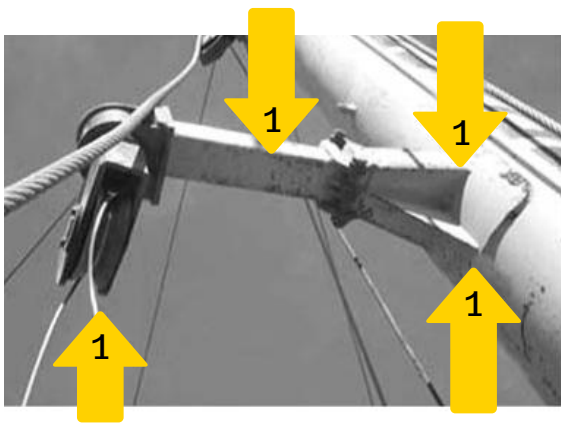

1. Visually check for alignment with the tower. Check that the support arm is not bent or cracked where it attaches to the spar. Also check that the sheave is in a direct line with the strawline or tagline drum. Strawline and tagline sheaves are often extended off to one side of the tower and are therefore prone to damage. Misalignment could cause the sheave to rub on the side plates causing damage to the rope.

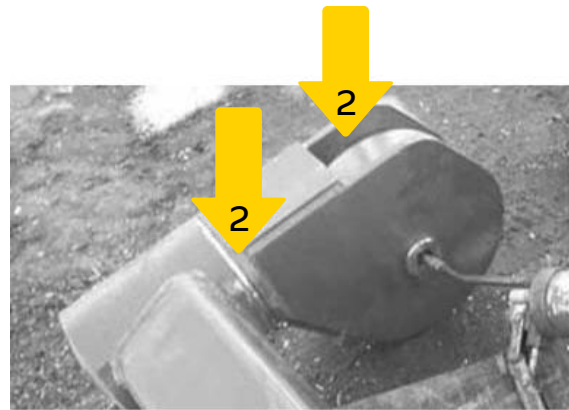

2. Check the cheek plates for cracks or damage.



3. Check for cracks around the pivot tube and pivot tube boss



4. Check the condition of the pivot bushes or bearings
5. Check for damage to the front of the cheek plates (such as spreading).

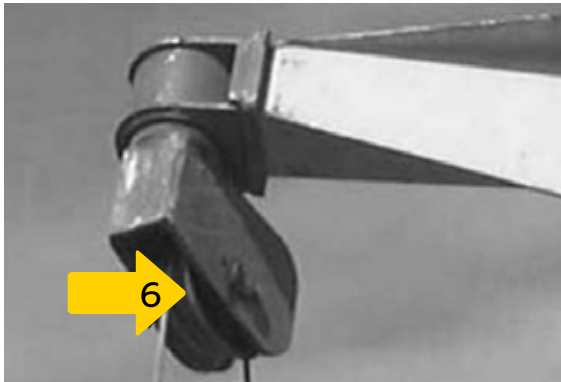

6. Check the condition of the sheaves for cracks, dents, rope marks.

**Note:** The strawline sheave does not have to be in as good condition as the tagline sheave, but it still has to be mechanically sound enough not to fail.

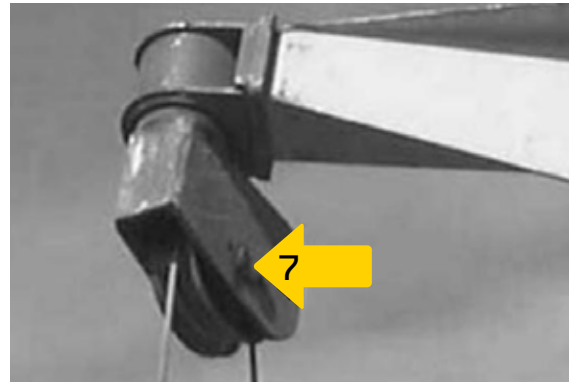

7. Check the condition of the sheave bearings, bearing axle, locking nut, and washer. To check the sheave bearing, rotate the sheave to see that it rotates freely. Then use a bar between the sheave and the sheave housing side plate to see if there is free play in the bearings.

## Deflection (or breaker) sheaves (where applicable)

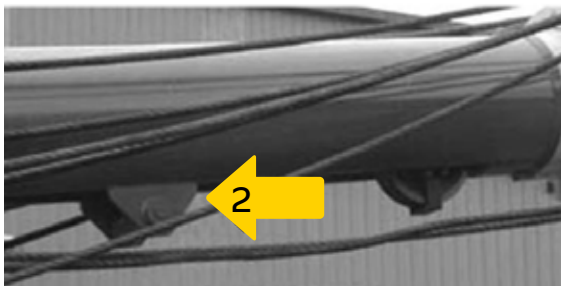

1. Visually check for alignment with the tower by looking to see if the sheave is in a direct line with its mating sheave and the drum. Deflection sheaves are high-speed working sheaves. Misalignment of the sheave could make it rub on the side plates, causing damage to the rope.
2. Check the cheek plates for cracks or damage where they attach to the tower.

3. Check for damage to the front of the cheek plates (such as spreading).

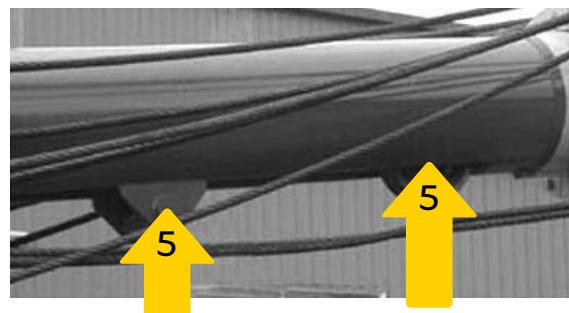
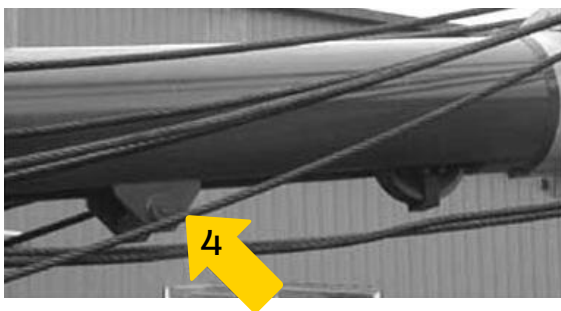

4. Check the condition of the sheave for cracks, dents, rope marks, and grease. Also check that the sheave has the correct rope radius for the rope size ( $\pm 5\%$  of each other).

5. Check the condition of the sheave bearings, bearing axle, locking nut, and washer. To check the sheave bearing, rotate the sheave to see that it rotates freely. Then use a bar between the sheave and the sheave housing side plate to see if there is free play in the bearings. Check that the mounting bolts are tight.

## Guyline blocks

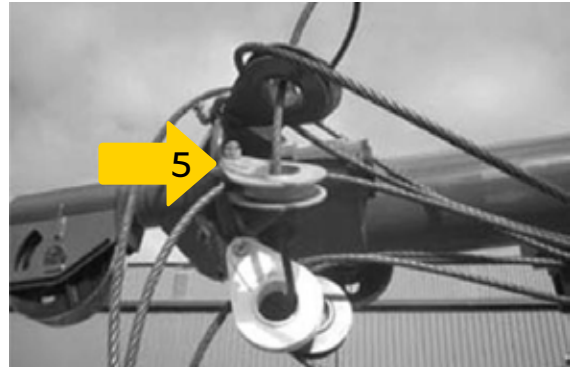

1. Check if the blocks are original equipment or an after-market design.
2. Check the condition of the sheave axle, looking for loose nuts, cracked welds, or general damage. Check the sheave bush or bearings by rotating the sheave to see that it rotates freely. Then use a bar between the sheave and the sheave housing side plate to see if there is free play in the bush or bearings.
3. Check the cheek plates for cracks or damage (such as spreading).
4. Check the condition of the sheave for cracks, dents, rope marks, and grease. Also check that the sheave has the correct rope radius for the rope size ( $<\pm 5\%$  of each other).
5. Check the mounting pin at the shackle connection. This pin should have no damage or bend at all

**Note:** These sheaves are not fast moving.

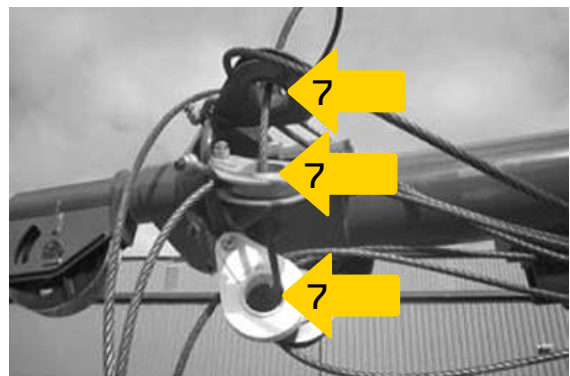
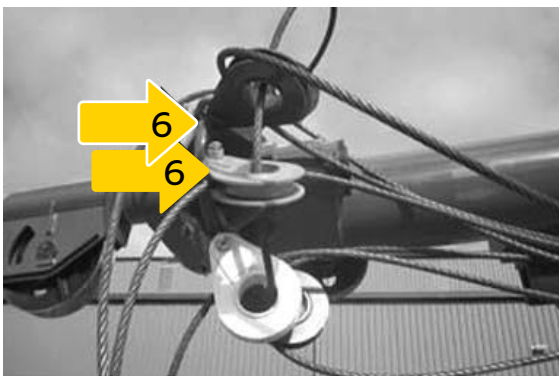

6. Check the guyblock shackles. Is there a bend in the shackle or shackle pin? Does the shackle have the required safe working load? Is the nut adequately secured?
7. Check the condition of the guyblock at the safety stop connection.

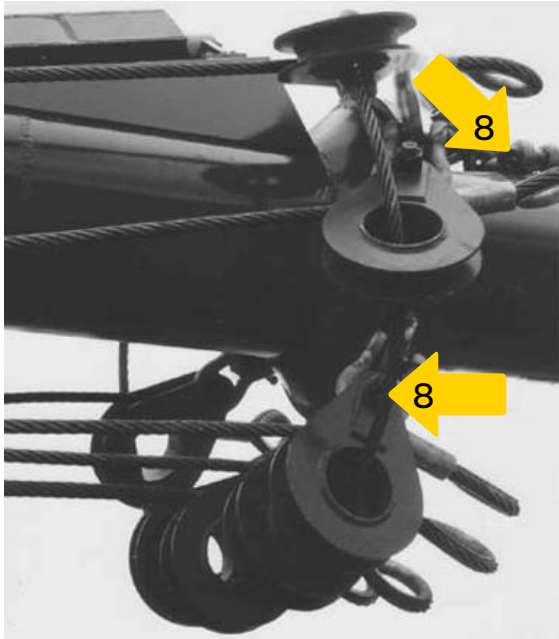

8. Check the condition of the safety stop and safety stop connection or shackle. The diameter of the safety stop shall be equal to that of the largest working rope (skyline or mainline).



## Tower (spar)

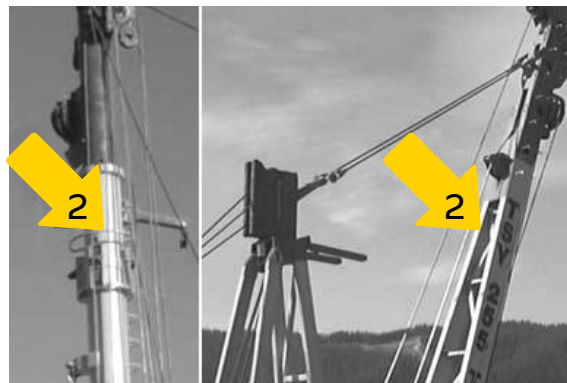

1. Check the tower identification plate is visible and that the rope sizes are in accordance with the identification plate.

**Notes:**

- a. If the tower is not uniquely identified by an identification plate or stamped serial number then the inspector must uniquely identify it. This is critical to guard against possible tower substitution during the currency of the inspection certificate. A suitable unique number (of which the inspector must maintain a register of numbers issued) must be hard stamped in an obvious location at the base of the tower. Some means of highlighting this number should be considered such as painting a contrasting colour. Further notes on identification of towers can be found under **Record keeping and reporting**.
- b. If the skyline rope size/strength is exceeded, a fuse link of the same breaking force or less than the guy ropes must be used.

2. Check the tower tube or frame (visual). Note any bends, dents, etc. (give measurements, location, photos).  
**Note:** When laid down, the tower will deflect and show a bend - this is normal. We are looking for an extraordinary bend

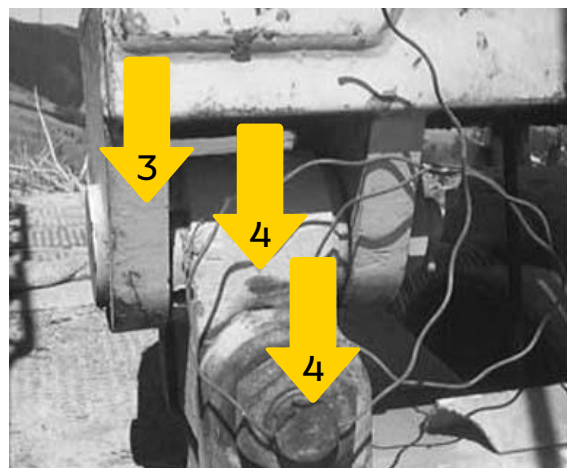

3. Check for cracks in the tower base plates and plate welds.
4. Check the bosses, pins, knuckles, and locking pin or clip (where applicable) for damage, cracks, or wear.

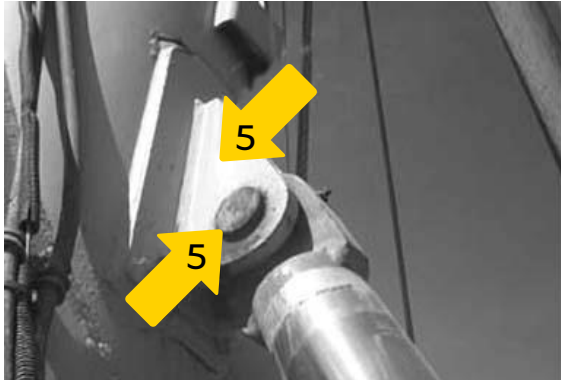

5. Check the tower-raising ram mounts and pins on both the tower and the chassis for cracks or damage. Have the pins got retainer clips, bolts, or washers fitted to stop them working loose? In the case of a tower-raising rope, check the raising rope, rope sheaves, and rope winch for cracks, damage, or wear.



6. Check tower-raising ram, hoses, and fittings for oil leaks, and check that the ram has a safety valve (counter balance valve) to stop the tower from coming down if a hydraulic hose blows.

**Note:** Some yarders don't have a tower-raising winch, in which case one of the working rope drums is used. The band brakes on that drum should be checked to see if the brake is capable of holding the tower.

7. Check the band brakes on the winch drum where the winch drum is used to raise and lower the tower.

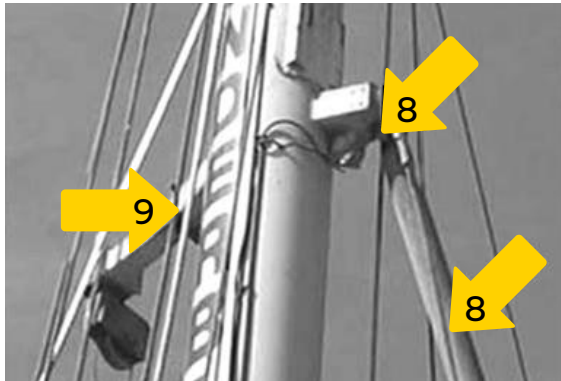

8. Check the stabiliser ram for oil leaks. Check the ram mounts and pins on both the tower and the winch set for cracks or damage. Have the pins got retainer clips, bolts, or washers fitted to stop them working loose?

Where a safety stop has been fitted to the stabiliser ram, check the condition of the rope, shackles, and the mounts. For yarders that have static guy ropes, check the age and condition of the static guy ropes, and the condition of shackles and mounts.

**Note:** Static guy ropes have a safe life span of 7 years from new (as recorded in the logbook). After this, they **must** be tested to ensure they are within manufacturers specifications or replaced.

9. Check for damage or cracks around attachment points to the tower of the strawline and tagline sheaves (where applicable).

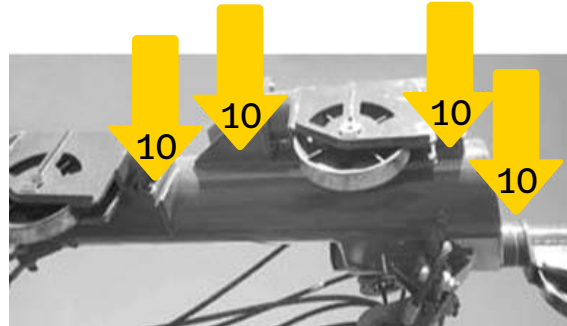

10. Check for damage or cracks around attachment points to the tower of the skyline, and the mainline and haulback sheaves (where applicable).

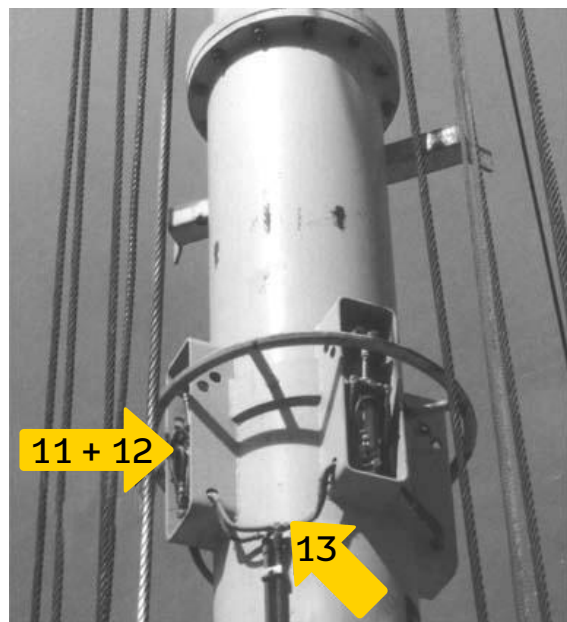

11. Check the tower locking dogs and flags for damage or cracks.
12. Check the dogs are easily visible (i.e., they are either a different colour or have a different coloured background - repaint if necessary).
13. Check air rams and air pipes for leaks or damage.
14. Check operation of telescopic tower air dogs.

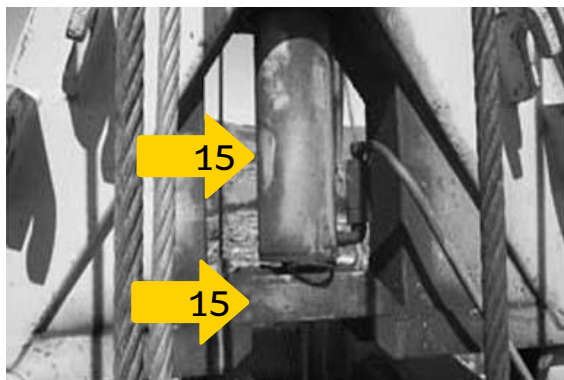

15. Check the tower telescope ram for oil leaks. Check the ram mounts and pins on both the top and the bottom sections of the tower for damage. Have the pins got retainer clips, bolts, or washers fitted to stop them working loose? Check their operation.

**Note:** These are multi-stage rams and will leak or weep even after they have been resealed.

16. Check the tower telescope rope, rope winch, and sheaves and sheave mounts for damage or cracks. Check their operation.

**Note:** Lifting ropes must be replaced 2 years from the "new" date recorded in the logbook.



17. Check guy ring or guy lugs where they attach to the tower for damage or cracks.

**Note:** This is a very critical area.

18. Check ladder rungs for damage which would not allow safe access up the tower.

## Guywinch

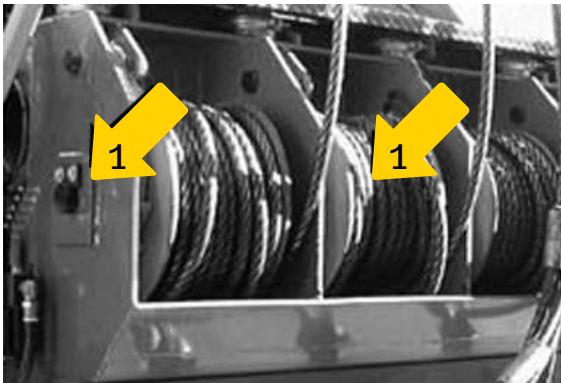

1. Check the guywinch drum and drum shaft for damage or wear. Check that the retaining clip, bolt, or washer is fitted to stop the shaft working loose.



2. Check the guywinch drum drive (sprockets, chain, and hydraulic motor) for damage or wear. Check the guywinch clutches where applicable.

**Note:** The guylines have a safe life span of 7 years for a tower yarder, and 5 years for a swing yarder (as recorded in the logbook). After this, they must be tested to ensure they are within manufacturers specifications or replaced.

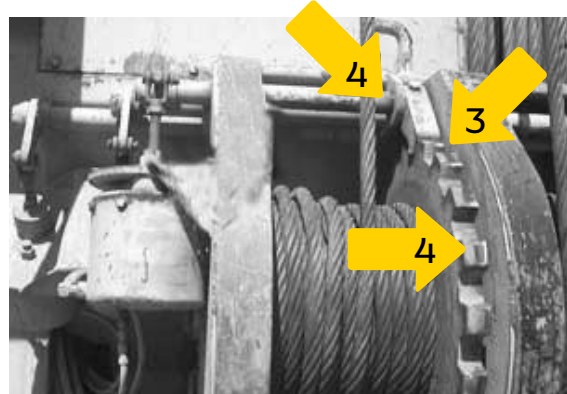

3. Check the guywinch ratchet wheels for cracks, wear, or damage. Check that the ratchet wheel meshes correctly with the ratchet pawl.
4. Check the guywinch pawls and pawl pins for damage or wear.

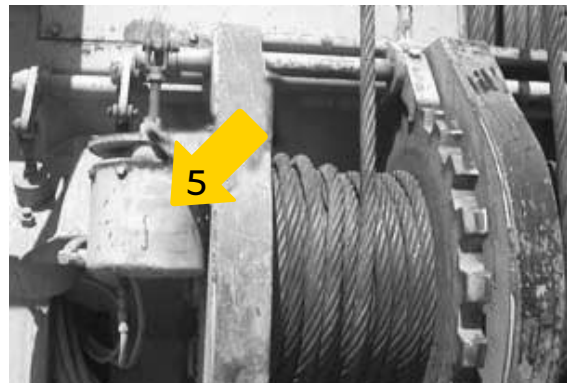

5. Check the pawl actuator for damage or wear. Check operation of the pawl.
6. Check the age and condition of the guyline and anchor points.
7. Check the ages and condition of the guyline extensions.

**Note:** Guyline extensions also have a safe life span of 7 years for a tower yarder, and 5 years for a swing yarder, as recorded in the logbook. After this they must be tested to ensure they are within manufacturers specifications or replaced.

## Tower (spar) mounting frame



1. Check the tower-mounting frame for damage, wear, or cracks in welds.

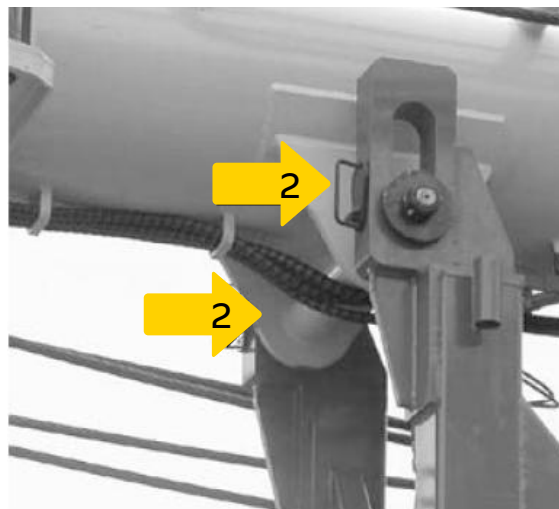

2. Check the tower-mounting bosses for damage, wear, or cracks in welds.

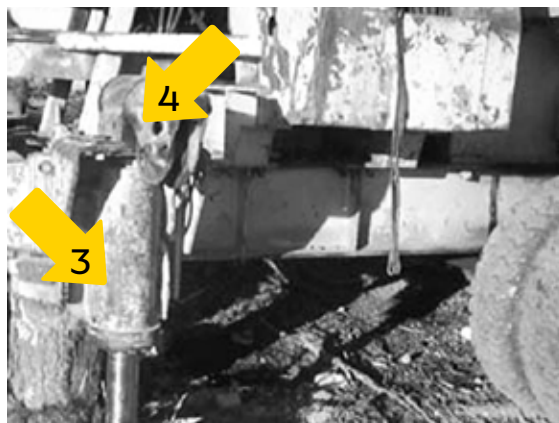

3. Check the levelling ram cylinders for leaks.
4. Check levelling ram cylinder mounts for damage or cracks. Check ground support frame or plate.

## Tower (spar) transport frame



1. Check the tower-mounting frame for damage, wear, or cracks in welds.

## Inspecting swing yarders

The following tower components are specific to swing yarders.

### Gantry frames



1. Check the pins and lugs at the bottom of the gantry legs for cracks or damage. Also check the locking pins.

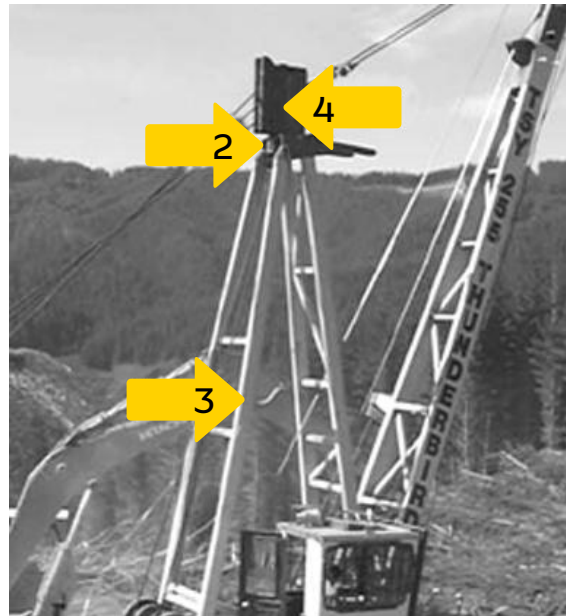

2. Check the pins and lugs at the top of the gantry legs for cracks or damage. Also check the locking pins.
3. Check the gantry frames for damage or cracks; check that the gantry legs are straight.
4. Check guyline fairlead housing and the base pivot for damage or cracks. Check that the guyline sheave rotates freely.





5. Check the roller tracks and stops on the rear gantry frame for damage or cracks.
6. Check the roller frame connecting the front and rear gantry frames for damage or cracks.
7. Check the pins, pin mounts, and rollers on the roller frame for damage or cracks.
8. Check the gantry-raising rope, rope winch or winch drum band brake, sheaves, and rope anchor point for damage or cracks.
9. Check the pendant rope, topping ropes or ropes connecting the gantry to the tower.

**Note:** Pendant ropes have a safe life span of 2 years from new (as recorded in the logbook). After that they must be replaced.

10. Check the pendant rope anchor points for damage or cracks.

## Side rollers (tower and gantry)



1. Check for worn rollers, worn roller axles (pins), axle retainers.
2. Check that the rollers turn freely on the bearings.
3. Check the shaft (pins) and retainers.
4. Check the shaft mounting lugs for damage or cracks.

## Slew ring and car body attachment

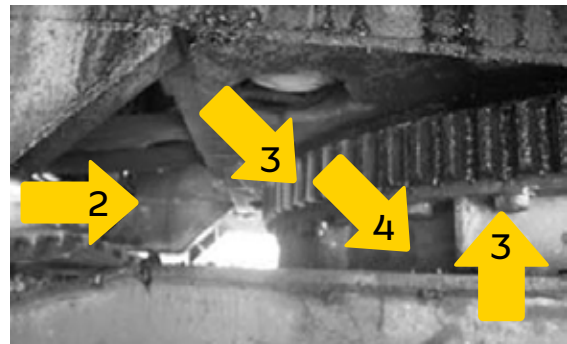

1. Check the slew ring mechanism for wear and that it works.
2. Check the slew motor pinion for damage or cracks.
3. Check the slew ring gear for damage or cracks. Check bolt tightness.

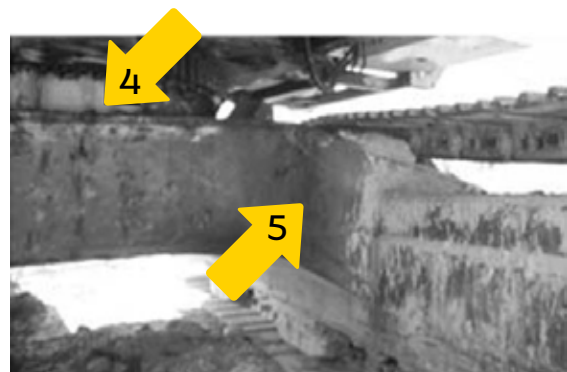

4. Check for damage or cracks where the slew ring attaches to the car body.
5. Check the car body for weld cracks or damage.

## Machine guarding

Machine guarding needs to conform, to the greatest extent practicable, with the requirements of AS/NZS 4024 *Safety of Machinery*. This is a series of Standards with very broad scope. It is not practical or necessary for the engineering safety inspector to possess all or even some parts of this Standard. Ownership of some parts may prove useful to have, but all of the essential information related to the work of the engineering safety inspector of cable log yarders is to be found in the WorkSafe NZ publication (May 2014) *Best Practice Guidelines for Safe Use of Machinery*. This publication describes how to do Hazard and Risk Assessments, Controls that can be put in place and Guarding measures than can be implemented if hazards and associated risks cannot be eliminated by design. The engineering safety inspector is advised to obtain a copy of this publication (downloadable free from the WSNZ website), familiarise themselves with it and reference it when writing reports.

Guards need to be effective, meaning they prevent people from coming in contact with the hazard, and not simple to defeat. By "not simple to defeat" is meant that the guard remains effective in preventing harm unless very determined efforts are made to circumvent it.

In many cases it will be necessary for maintenance staff to access whatever is protected by the guard when the machine is in its operating condition in order to adjust or assess it. This is permissible so long as the guard can only be removed by skilled persons having specialised tools which are unlikely to be in the possession of the operator of the machine or workers who may need to access the machine. The catches or fasteners used to secure the

guard in this instance need to be removable or openable "using tools" only likely to be in the possession of the skilled maintainer. Quite what these "tools" are will vary depending on the circumstances. If, for instance, it was necessary for the operator to have spanners and sockets to make adjustments on the machine, the guard should not be secured with hex-head bolts. In-hex socket screws might be appropriate or perhaps a specialised anti-tamper screw or bolt might be required.

A different situation arises if hazardous parts need to be accessed often and by the operator or workers on the machine. If the hazard that has been guarded must be stationary before it will be safe to access, then *safety interlocking* of some type may be required. "Safety Interlocking" means that opening/removing the guard is either impossible without first stopping the machine or opening/removing the guard stops the machine, rendering it impossible to restart until the guard is replaced. There are many types of Safety Interlocking that can be utilised, from simple mechanical systems to relatively sophisticated systems. Systems may need to be increasingly sophisticated where stored energy is involved, perhaps as heavy or fast rotating parts or where systems are pressurised. Which type is required needs to be assessed by a competent practitioner on the basis of the significance of the hazard, the likelihood of the risk, the potential severity of the harm and the practicality of implementing a guarding solution.

Section 22 of the Health and Safety at Work Act 2015 defines "reasonably practicable":

### Meaning of reasonably practicable

In this Act, unless the context otherwise requires, reasonably practicable, in relation to a duty of a PCBU set out in subpart 2 of Part 2, means that which is, or was, at a particular time, reasonably able to be done in relation to ensuring health and safety, taking into account and weighing up all relevant matters, including—

- (a) the likelihood of the hazard or the risk concerned occurring; and
- (b) the degree of harm that might result from the hazard or risk; and
- (c) what the person concerned knows, or ought reasonably to know, about—
  - (i) the hazard or risk; and
  - (ii) ways of eliminating or minimising the risk; and
- (d) the availability and suitability of ways to eliminate or minimise the risk; and
- (e) after assessing the extent of the risk and the available ways of eliminating or minimising the risk, the cost associated with available ways of eliminating or minimising the risk, including whether the cost is grossly disproportionate to the risk.

Note that, while a valid consideration, “cost” is the last consideration to be applied using the criteria of HSWA. “Grossly disproportionate to the risk” is an evaluation that needs to be made by the PCBU.

What is expected of the engineering safety inspector is that they are able to assess hazards on this class of machinery, decide if guarding is required (if it is not present) and if the method of securing such guarding (fixed guards, interlocking etc.) is adequate. The output of this evaluation should be recommendations to the equipment owner concerning the adequacy of guarding. If the engineering safety inspector is not confident to make some types of recommendations, then the recommendation should always be for the PCBU to engage a competent machine guarding practitioner.

## Commonly encountered machine guarding hazards and associated risks on cable log yarders and their possible solution.

Hazard	Possible Guarding Solution
Rotating shafts	Fixed guarding, with safe access for greasing or inspection
Exposed keys	Fixed guarding.
Clutches	Fixed guarding, with safe access for greasing and/or adjustment.
Hot parts	Fixed, insulated guarding (air gaps etc.)
Engine covers	As provided by the engine manufacturer and as warranted by the installation.
Chains	Fixed, fully enclosed guards, with provision for shaft centre adjustment
Nip points	In-running nips of chains and belts must be protected with fixed guards.
Crushing	Fixed guards if practicable, otherwise minimise hazards and associated risks by clear signage e.g., parts that move relative to one another and create decreasing spaces as towers are erected or lowered.
Winch and rope guarding	Fixed guarding as practicable.
Entrapment	Lock-out systems to prevent guards closing and machinery starting while workers are inside machine spaces.
Entanglement	Fixed or freely revolving guards on shafts. All potentially engaging shaft ends, keys, grease nipples etc to be guarded. Outer garments and PPE to be close fitting.

## Safe Access

Access to cable log yarders needs to be of the same standard applied to any other workplace. WorkSafe NZ publication (April 2012) *Best Practice Guidelines for Working at Height in New Zealand* is the primary reference document. This publication describes the measures that can be reasonably taken to provide safe access to equipment such as cable log yarders that are physically large with many elevated surfaces. The engineering safety inspector is advised to obtain a copy of this publication (downloadable free from the WSNZ website), familiarise themselves with it and reference it when writing reports.

The type of access to be provided will depend on how often particular aspects of the machine need to be accessed – and what needs to be done once there. Some regularly accessed areas (such as the operator's cab) must have safe and convenient access for people of varying physical abilities. The same standards applied to industrial stairways and platforms are appropriate with the exception that it may reasonably be assumed that children will not be permitted on the machine (meaning some side guarding protection may not be necessary). Additional measures may be required to anticipate use by persons with muddy footwear.

When considering whether certain access provided is adequate be sure to evaluate the risk to those below from dropped objects; kickplates and mid-rails are generally essential. Similarly, expanded mesh-type deck-plates are widely used on logging equipment, being free draining and highly slip-resistant. However, the risk of

small parts or tools falling through overly large mesh or grids needs to be considered. The BPG references AS/NZS 1657 for the design of fixed platforms, walkways, stairways and ladders. AS/NZS 1657 provides clear guidance on where a stair or a ladder is appropriate (for instance) and what dimensions and strength requirements are to be applied.

There is a pervasive myth in industry that if the potential fall is less than 3 metres then handrails or other fall protection are not required. This is false. There is now case law to show that the hazard and the risk are what need to be addressed by the PCBU. Plainly, in some circumstances a fall from even a very low height could be hazardous and people must be protected from this.

While it may be permissible to access some parts of the machine (either as an inspector or a worker on the machine) it is generally true that simple safe access results in better, more frequent maintenance and better inspection outcomes. Accordingly, access using work-positioning or fall arrest harness-type equipment should be a distant second option compared to access from proper accessways. Elevating Work Platforms (EWPs) are a good option to consider, but often expensive and inconvenient in the relatively remote locations in which cable logging equipment is often found.

If access using work-positioning or fall arrest harness-type equipment is a workplace reality, anchorages and lifelines used must be designed and certified to appropriate Standards: AS/NZS 1891.2 for lifelines and AS/NZS 1891.4 for work positioning/fall arrest anchorages.

It is recommended that inspectors check that anchors are certified before entrusting their safety to them.

What is expected of the engineering safety inspector is that they are able to assess the appropriateness and adequacy of safe access provisions on this class of machinery. The output of this evaluation should be recommendations to the equipment owner concerning the adequacy of the safe access provided. If the engineering safety inspector is not confident to make some types of recommendations, then the recommendation should always be for the PCBU to engage a competent safe access practitioner.

Examples of guarding issues specific to yarders are given in Appendix A

## Mechanical and Control

*Mechanical elements* are those that rotate, extend, retract or otherwise move in some manner to cause the cable yarder to fulfil its intended function (as opposed to structural elements, which are largely static).

*Control elements* are the devices and systems that cause the mechanical elements to start, stop, change speed or direction.

Failure of a mechanical or control element could be every bit as hazardous as failure of a structural element. A periodic independent assessment by an Engineering Safety Inspector is therefore required to overview these systems.

It should be noted that dismantling of equipment or removing of covers is not generally expected or required. The purpose of these inspections is to assess function and performance, rather than condition. Condition assessment is a maintenance requirement. It is accepted that there may be instances where a functional inspection will fail to detect a component that appears satisfactory at the time of inspection, but which subsequently fails because it had a defect or wear that did not show up when testing the function.

This is a reality of independent 3rd party inspections of this type. In this sense, the inspections being performed are no different to that undertaken by a Warrant of Fitness Inspector on a road vehicle. What was seen and assessed on the day is all that can be certified – and is the reason certificates of this type will often contain wording to the effect "*This is to certify that the equipment described was inspected and found to be safe at the date of the*

*inspection and will remain safe for the period of the certificate if operated and maintained properly*".

Some mechanical and control elements will be safety-critical, and others will not. It is for the inspector to apply their industry and engineering judgement to decide which elements are critical to the safe operation of any particular yarder and expand or contract the following list as appropriate.

Any modifications to the OEM controls (such as conversion from lever to joystick control) are to be approved by a competent person (e.g., a CPEng), including modifications to software. This is so that any consequential risks can be identified and eliminated or mitigated.



Element	Function tested
<b>Winch pack</b>	Correct for machine, correctly mounted and guarded
<b>Brake condition</b>	Lining thicknesses (as accessible) Bands correctly positioned Band anchors Band actuators
<b>Brake function</b>	Smooth and progressive actuation Holding power (perhaps assessed by driving against brake) Holding on correctly (not leaking off)
<b>Brake actuators (pots)</b>	Correct size for application Age (best practice is to replace annually) Pins and linkages working through correct arcs and angles
<b>Brake adjusters</b>	Within working range (not out of adjustment, stroke etc.) Working freely (not seized)
<b>Control panel</b>	Gauges – present and working (manufacturer's data may be required) Controls – present, working and correctly oriented Labels – present, legible and correct
<b>Joystick-type controls</b>	Functions correctly oriented with respect to machine Clear labelling Certificate on file for control modification if controls are not OEM
<b>Hydraulic systems</b>	No leaks Hose failure protection as appropriate

## Operator Protective Structures (OPS)

Operator Protective Structures (OPS) are intended to protect the operator from the physical hazards that may arise due to the necessary close proximity of the operator to:

- Heavy slow-moving objects, such as logs being in-hauled or manoeuvred by other log handling machinery in the area.
- Fast moving smaller objects, such as wire ropes or projectiles from some other source.
- Falling objects, such as tree parts falling from above or machine/rigging parts like broken shackles.
- The principal reference document is the Approved Code of Practice for Operator Protective Structures on Self-Propelled Mobile Plant. Legally speaking, an Approved Code of Practice sits immediately below Regulations (an Act). An ACoP gives interpretation and explanation of certain parts of an Act.
- The OPS can only function as required by the law if it is properly certified and in good condition.
- OPS are either certified by the Original Equipment Manufacturer (OEM) or by a Chartered Professional Engineer (CPEng). A CPEng is an engineer on the current New Zealand CPEng Register (a high-level engineering competence assessment system) who is bound by a Code of Ethics to only practice within his/her areas of competence. The majority of OPS in New Zealand have been certified by CPEngs.
- The independent inspector is not usually a Chartered Professional Engineer. Accordingly, the inspector is not able to certify a structure, but, using these guidelines, will be able to provide useful feedback to the yarder owner on the compliance status of OPS and thereby help ensure the safety of those operating such equipment.
- Yarders require both FOPS and OPS (but not ROPS)
- ROPS = Roll-Over Protective Structure
- FOPS = Falling Object Protective Structure
  - Usually to ISO 8083 (1989 or 2006), a "laboratory test standard". For low volume production, structures are most commonly verified by analysis, physical testing being impractical.
  - Asserts ability of structure to absorb energy
  - Typically, 229 kg dropped from 5.16m (=11.6 kJ)
- OPS = Side (or roof) Intrusion
  - This can be confusing as "OPS" is sometimes used interchangeably to mean either the whole structure or just the side/roof intrusion protection.
  - Usually to ISO 8084 (either 1993 or 2003 – 1993 is more commonly used) – also a "laboratory test standard".
  - Asserts ability of structure to withstand side (or maybe vertical) loading without intrusion into the space occupied by a 'standard' operator.
  - 17.8 kN (2 US Tons) distributed over Ø200 load distributor plate.

- Can be constructed from:
  - Steel bars (round or rectangular)
  - Woven steel mesh
  - Polycarbonate plate
  - Laminated glass plate
  - A combination of steel bars and glass or polycarbonate may be used to construct an OPS system rated for both ISO 8084 loading and chainshot. Very thick polycarbonate may be rated for both without additional steel bar reinforcement.



## Inspection Elements

### Identification/ Certification Data Plate (Tag)

Expect to find:

- Certifying Engineer and/or Manufacturer
- OPS Structure Serial Number
- Machine Serial Number (check this matches the yarder itself)
- Standards certified to:
  - FOPS ISO 8083
  - OPS ISO 8084
  - Other Standards may be acceptable, but they must be listed in Appendix A of the ACoP. If in doubt, seek advice from a certifying engineer.
- Expiry date. See Duration of Certification notes below.

### Invalid Certification Data Plates

Invalid certifications may be found.  
Examples include:

- No certification plate found.
  - If the plate has been removed for some reason, or lost, it must be replaced.
  - The structure may never have been fitted with a plate from new. This is sometimes the case with older North American yarders. If in doubt, seek advice from a certifying engineer
- The structure might have been certified (either by the manufacturer or a NZ certifier) with "WCB-type" grills. These are readily identifiable having typically large aperture size (150 – 200 mm) and are not accepted by WorkSafe NZ as being fit for purpose in NZ forests without suitable secondary protection in place to catch small objects which may pass through the primary large-pitch grill. These secondary systems may comprise of polycarbonate plate or heavy laminated glass and need to be certified by a CPEng. In general, a large-pitch grill backed only by 6 – 8 mm glass is unlikely to be legitimately certified.
- Certified OPS grills are typically designed with a nominal bar pitch of around 100 mm. Again, if in doubt, seek advice from a certifying engineer

## Duration of Certification

WorkSafe NZ issued a Technical Bulletin in September 2018 which states that certification may be for:

- Ten years (from new) if issued by the original manufacturer or a CPEng.
- Five years if issued as a recertification.

## Condition Assessment - OPS

- No structural damage, rust, broken welds, significantly bent bars etc.
- No broken glass.
- Polycarbonate not badly scratched, crazed or discoloured.
- Cab mounts (if of the resilient rubber type) must be sound, and not visibly perished. All mounting bolts etc. must be present. They must not appear strained. Any movement limitation devices fitted to the mounts must be present and in good order.
- No unauthorised modifications (lifting lugs, cut-outs etc.)
- No bolts missing from two-piece cabs.
- Tilting cabs have pivot pins and lock-down bolts or pins in place.
- If a roof skylight is fitted, the grill or polycarbonate plate protection system must be in good order.
- OPS systems must all be in place i.e. if it is apparent a particular window or side of the structure should/has been guarded, this guard must be in place.
- On a swing yarder, the front OPS guard may be remote from the cab, typically fitted to the boom. Nonetheless, this guard forms part of the certified structure.

## Condition Assessment - FOPS

- FOPS (roof) plate should be undamaged and unmodified.
- Minor dents and knocks are of little consequence. A dent more than twice the thickness of the roof plate material should be noted.
- Creases or cuts are unacceptable.
- Unauthorised modifications, such as lifting lugs, can cause premature failure of the FOPS if struck by a heavy falling object. The lug (or similar) acts as a pressure point and may cause rupture.
- The FOPS should be free from corrosion.

## Repairs and Modifications

- Repairs (or modifications) to OPS or FOPS must be done under the supervision of a CPEng certifying engineer who will also issue a certificate for the completed work.
- The Certifying engineer will require welding and weld inspection by suitably qualified persons.
- Repairs must be documented in the Log Book.

## Reporting OPS Compliance

- Reporting is best done by adding a separate section into the existing reporting structure. A suitable example is given in Appendix B.
- Should the inspector have any doubt regarding any feature of the condition or design of the OPS then a sound recommendation to make is that the yarder owner should engage a CPEng to advise on the matter.
- The 'tone' of this reporting should be advisory and informative rather than implying the findings are binding and mandatory. The independent inspector has partially fulfilled his/her obligations as a skilled observer (under the Health and Safety at Work Act) by reporting the OPS compliance status to the owner in this manner.
- Should the independent inspector have reasonable grounds to believe an OPS is potentially dangerous due to its design or condition and that the owner is unlikely to action reasonable recommendations made in the report then the inspector should take the further step of reporting the matter to WSNZ to fully discharge his/her responsibilities under the Act.

## Wire Ropes

### Maximum Replacement Intervals

Structural Rope	Maximum period before replacement (years)	
	Pole-type yarder	Swing-type yarder
Guy Ropes	7	5
Static guys	7	7
Guy line extensions	7	7
Pendent ropes		2
Topping lines		2
Tower raising ropes	2	
Tower extension ropes	2	
Safety strop	7	

## Rope Condition Assessment

For the purposes of the engineering safety inspection only the ropes listed in the table above need to be considered as these relate to the structure of the cable yarder. The working ropes (mainline, skyline, haulback, strawline etc.) do not directly influence the structure of the yarder; working ropes are the responsibility of the operator and the yarder operating crew. These working ropes are generally considered satisfactory even when their condition had deteriorated to a standard that would not be acceptable for structural ropes.

Structural ropes, as listed in the table above, are required to be in serviceable condition at all times as the stability of the tower or safety of the lowering

and raising operations depends upon them. The yarder manufacturer will have carefully considered the size and strength requirements for all structural ropes. It is essential that specified sizes, construction and minimum breaking loads are complied with when structural ropes are replaced. Checking that these ropes are correct for the application is an important part of the engineering safety inspection. Reference should be made to the machine data plate, machine Maintenance Manual and the Logbook in addition to physical measurements and condition assessments.

## Some Causes of Wire Rope Failure

- **Corrosion** – due to lack of lubrication during use or in storage
- **Crushing** – due to poor spooling and overloading. If a large amount of rope is put on a drum yet only the top layers are working the bottom layers must be put on tightly. Thus, the care shown in winding on the bottom layers has a critical effect on the life of the rope.
- **Fatigue** – use of small sheaves and drums causes early breakage due to extreme bending fatigue. An example of this is guy ropes, which are often relatively large diameter ropes wound onto drums of a diameter that is less than optimal due to space considerations.
- **Incorrect handling** – during installation, causing kinks, bruising or slipping of the lay.
- **Worn sheaves** – sheaves that have become corrugated or worn so that the rope runs on the sides of the sheave will cause early rope failure.
- **Shock loads** – can cause severe unseen damage and shorten the service life of wire ropes.
- **Incorrect rope** – all ropes are constructed to meet a specific purpose. Using the incorrect rope in a given situation will lead to premature failure.
- **Seized or dragging sheaves** – will create intense heat through friction resulting in excessive wear and early failure.
- **Improper termination** – causes slackness in strands which will work its way along the rope causing the rope to become unevenly loaded across its cross-section.
- **Reverse bending** - where a rope passing over one sheave switches sharply in the opposite direction. This is an issue that should have been addressed at the design stage by the use of larger sheaves or more flexible rope construction. However, space considerations may have prevented ideal design solutions leading to the possibility of early rope failure from this cause.



## Discard Criteria

ISO 4309 *Cranes – Wire Ropes – Care and maintenance, inspection and discard* is the reference Standard used within the crane industry. It is largely applicable to the structural and working ropes found on cable log yarders.

Section 6.1 of ISO 4309 provides excellent general guidance:

In the absence of any instructions provided by the manufacturer of the machine or the rope individual discard criteria is given further in the Standard.

As deterioration of ropes often results from a combination of different modes at the same position in the rope the competent person shall assess the "combined effect". A suggested method is given in Appendix G of the Standard.

If, for whatever reason, there is a noticeable change in the rate of deterioration of the rope, the reason for this shall be investigated. In extreme cases, the competent person may decide to discard the rope, reduce the time for the next periodic inspection, or amend the discard criteria, for example, by reducing the allowable number of visible broken wires.

In those instances where a rope of long length has suffered deterioration over a relatively short section the competent person may decide that it is satisfactory to shorten the rope.

ISO 4309 contains detailed discard criteria related to the type of rope and the defect found along with illustrations of the various defect types which cannot be replicated here for copyright reasons. Engineering Safety Inspectors are encouraged to obtain and hold a copy of this Standard for their reference.

Discard criteria include:

1. **Excessive number of broken wires** - within a set number of rope diameters. This depends on the rope's construction, but typically not more than 6 breaks along six diameters of rope is permissible.
2. **Decrease in rope diameter** – typically if the rope diameter has uniformly decreased by more than 10% it must be discarded. Any obvious localised decrease is grounds for discarding
3. **Strand fracture** – the rope shall be immediately discarded.
4. **External corrosion** - if the wire surface is heavily pitted and some wires are slack, discard immediately.
5. **Waviness** – discard if the gap between a straightedge and the underside of the rope helix is greater than Rope Diameter  $\div$  3.
6. **Basket deformation** – immediate discard.
7. **Core or strand protrusion** - immediate discard.
8. **Local increase in wire diameter** – localised swelling of more than 5% (steel core) or 10% (fibre core) is generally grounds for discard.
9. **Flattened portions of rope** – that run through sheaves are generally grounds for discard.
10. **Bend in rope** – immediate discard.
11. **Damage due to heat or electric arcing** – recognisable by discolouration and/or distinct loss of grease. Grounds for discard if two or more wires have been affected locally.

## Typical examples of wire rope deterioration

1. Mechanical damage due to rope movement over sharp edge projection whilst under load.



2. Localised wear due to abrasion on supporting structure. Vibration of rope between drum and jib head sheave.



3. Narrow path of wear resulting in fatigue fractures, caused by working in a grossly oversize groove, or over small support rollers.



4. Two parallel paths of broken wires indicative of bending through an undersize groove in the sheave.



5. Severe wear, associated with high tread pressure. Protrusion of fibre main core.



6. Severe wear in Langs Lay, caused by abrasion at cross-over points on multi-layer coiling application.



7. Corrosion of severe degree caused by immersion of rope in chemically treated water.



8. Internal corrosion prominent while external surface shows little evidence of deterioration. Complete lack of strand gap suggests internal degradation.

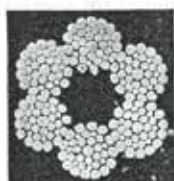

9. Typical wire fractures as a result of bend fatigue.



10. Wire fractures at the strand, or core interfaces, as distinct from 'crowns' fractures, caused by failure of core support.



11. Break up of IWRC resulting from high stress application. Note nicking of wires in outer strands.



12. Strand core protrusion as a result of torsional unbalance created by 'drop ball' application. (i.e. shock loading).



13. Typical example of localised wear and deformation created at a previously kinked portion of rope.



14. Multi strand rope 'bird caged' due to torsional unbalance. Typical of build up seen at anchorage end of multi-fall crane application.



15. Protrusion of IWRC resulting from shock loading.



16. Substantial wear and severe internal corrosion. High tension, abrasion and corrosive environment are combined in this example.

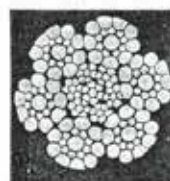

# Part C

## Record keeping and reporting



A record (Report) of each inspection shall be supplied to the contractor (or agent) by the engineering safety inspector (a copy will also be retained by the inspector). This record, identified by a unique number, will include the date of the inspection, yarder details, inspector name and details (including valid inspector CBIP number), and the inspection results.

There are four possible results of a yarder inspection:

1. The yarder achieved the industry standard
2. Specific (Major) repairs need to be completed before the yarder can achieve the industry standard. The machine must not be used in the interim
3. Specific (Minor) repairs need to be completed within a given time (maximum of one month). The machine can be used in the interim, but will require inspection of the completed work before a full-term certificate can be issued.
4. Maintenance issues have been identified which must be rectified before the next annual inspection.

Once the yarder achieves the industry standard (i.e., it passes), an inspection certificate (label, plate, sticker) will be issued by the engineering safety inspector. This certificate must display the following information:

- Machine/tower serial number
- Expiry date
- Inspector CBIP number
- Inspector name/company details
- Inspector certificate number

The expiry date on the certificate will be 12-months after the last full inspection of the yarder. This means that if repairs took one month to complete and a full reinspection was not done, the expiry date will be based on the initial inspection date.

Once a certificate and associated paperwork is issued, the owner, contractor (or agent) is responsible for ensuring that the certificate is displayed on the yarder and that the details of the inspections (and any repairs) are recorded in the logbook.

If it is found necessary to issue a number to uniquely identify the tower (refer to [Tower \(spar\)](#)) the inspector must record the details of this issue in a register (either on paper or digitally) in a form in which this information can be readily retrieved. A suggested format is <CBIP # - YYYYMMDD>. For example, a number allocated by CBIP inspector #4321 on 8th September 2021 would be "4321-210908".

## Glossary of terms

<b>Breaker-outs</b>	Workers who connect the stops onto the stems for extraction by the yarder
<b>Car body</b>	The undercarriage of a swing yarder capable of propelling and swinging the main body and tower.
<b>Certified welder</b>	A welder who holds current welding certification approved to AS/NZS 2980 (or equivalent) in the position(s) appropriate to the welding task.
<b>Compressive stress</b>	A stress that tends to shorten a material.
<b>Elastic limit</b>	The stress that a material can withstand before permanent deformation occurs when the stress is released.
<b>Excavator yarder</b>	An excavator-based machine fitted with a drum set for cable extraction.
<b>Fatigue</b>	A mode of failure that can occur without warning and at a stress much lower than the ultimate stress for the material. Often associated with shafts and other rotating components, but any equipment subjected to cyclic loading is potentially susceptible. Usually has its origin in some surface imperfections (sometimes an imperfection below the surface can be the cause).
<b>Guyline configuration</b>	The guyline angles (vertical) and spacing relative to the direction of pull.
<b>Independent spar yarder</b>	A yarder winch (one or two drums) with a separate guyed spar or tower.
<b>Integral fixed tower yarder</b>	A yarder with a built-in tower not capable of swinging relative to the chassis or car body.
<b>Chartered Professional Engineer</b>	A qualified mechanical or structural engineer holding a current Practising Certificate as a Chartered Professional Engineer.

<b>Shear stress</b>	A stress which tends to shear a material.
<b>Skid worker (Skiddy)</b>	A worker on the landing typically involved with trimming, cutting up stems, and quality control.
<b>Strain</b>	A change in a material's dimensions when a stress is applied
<b>Stress</b>	The load transmitted per unit area of cross-section, usually expressed in MPa (megapascals).
<b>Swing yarder</b>	An integral tower yarder capable of swinging the tower relative to the car body.
<b>Tensile stress</b>	A stress which tends to stretch a material.
<b>Ultimate strength</b>	A property of a material that corresponds with the maximum stress that a material can withstand before failing.
<b>Yield strength</b>	A property of a material that corresponds with the maximum stress that a material can withstand before permanent deformation (dimensional change) occurs.

## Appendix A

### Yarder machine guarding issues and examples (courtesy WorkSafe NZ)

#### Guarding



Missing guard.

Guard needs to be fixed such that "tools" not generally accessible to the operators are needed to remove,



Guard replaced



Rotating clutch accessible to workers when greasing machinery



Gate-type guard fitted.

Depending on the risk, opening of guards of this type may have to be interlocked to machine operation i.e. opening the guard should not be possible until the guarded parts have come to a standstill and cannot be re-started while the guard is open.



Entanglement risk from exposed belts and pulleys.

Danger of burns from hot exhaust and other engine parts.



Comprehensively guarded engine compartment. Again, depending on the risks, interlocking may be required.



OEM handrails missing on a swing yarder winch set – original mounting points arrowed.





Incomplete guard over clutch adjacent to (substandard) walkway used to access far side of machine.



OEM guard (missing) had been replaced with the welded mesh shown after a toe amputation. Guard was not removable "using tools", so has been cut out at some time to attach a new skyline.



Unguarded potentially hot exhaust and muffler adjacent to access ladder.



Damaged mesh guard over rotating parts. Access by skilled personnel may be required for maintenance with parts rotating. A risk assessment should be undertaken to decide if interlocking or other measures are required.



Guards removed and not replaced. Bolt holes visible where arrowed.



Guard missing over exposed gearing and moving ropes

## Safe Access



Unguarded rotating machinery accessed by unsafe walkway - lack of: sufficient clearances, handrails/kickplates, non-slip walkway surface.



New handrail, but:

- no end railing
- no kick plates
- walkway not non-slip



Similarly, handrail open at ends and no kick plates.

Unguarded chute where strawline exits.

Should also be protection from winch drum set and moving ropes.



Unstable, unsuitable access.



Worker access to gantry ladder is by climbing up guy winches (less than ideal) and where the handrails have been crushed (dangerous).



Unsafe access.



Improved access with integral ladder.  
Needs kickplates added and something better than the de-barked log as a lower step.



Winch drums guarded during normal operations.

Note handrails, mid-rails and kickplates.

Cover lifting eyes have been identified as a trip hazard and should be replaced with fold-flat types.

Rail sections are relocatable to provide access when required while ensuring height safety.



Addition of a handrail and non-slip surface to log step would probably make this an acceptable access solution.

## Appendix B – Certified Inspection Plate

**YARDER SAFETY INSPECTION**

INSPECTION CERT No:.....

MANUFACTURER:.....MODEL:.....

MACHINE SERIAL No:.....TOWER SERIAL No:.....

INSPECTION DATE:.....

INSPECTION DUE ON OR BEFORE:.....

INSPECTOR:.....TI No:.....

NEXT INSPECTION DATE: \_\_\_\_\_ / \_\_\_\_\_ / 20 \_\_\_\_\_

  
FOREST INDUSTRY  
CONTRACTORS  
ASSOCIATION

PH: 0800 342 269  
EMAIL: [office@fica.org.nz](mailto:office@fica.org.nz)

# Appendix C - OPS Compliance Reporting Form

## Tower Check



Tower Name:	Madil	Model:	171
Manuf./SN:		Tower S/N:	
Location:	Hoult valley	Owner:	Moutere Logging
Owners address:		Start date of survey:	29-Apr-2021
Finish date of survey:	29-Apr-2021	Expiry date:	29-Apr-2021
Inspector:	Phil Kirk	Plant ID:	Moutere 1

GPS:





Safety critical issues summary
////

KEY ✓ = satisfactory for certification X = not certified, repairs required - = not applicable  
 N- could not inspect R = repairs by next inspection date S = specific inspection notes

1.0 Skyline Sheave		
Item	Code	Comment
1.1 Alignment with tower		
Image	Image	Image
		
1.2 Check plates		
1.3 Pivot		
1.4 Housing		
Was there a safety critical issue?	No	

2.0 Mainline Sheave		
Item	Code	Comment
2.1 Alignment with tower		
Image	Image	Video
		
2.2 Cheek plates		
2.3 Pivot		
2.4 Housing		
Was there a safety critical issue?	No	
3.0 Haulback Sheave		
Item	Code	Comment
3.1 Alignment with tower		
3.2 Cheek plates		
3.3 Pivot		
3.4 Housing		
Was there a safety critical issue?	No	
4.0 Strawline Sheave		
Item	Code	Comment
4.1 Alignment with tower		
4.2 Cheek plates		
4.3 Pivot		
4.4 Housing		
Was there a safety critical issue?	No	



5.0 Tagline Sheave		
Item	Code	Comment
5.1 Alignment with tower	N	
5.2 Cheek plates	N	
5.3 Pivot	N	
5.4 Housing	N	
Was there a safety critical issue?	No	
6.0 Deflection Sheaves		
Item	Code	Comment
6.1 Alignment with tower		
Image	Image	Video
		
6.2 Cheek plates	N	
6.3 Pivot	N	
6.4 Housing	N	
Was there a safety critical issue?	No	
7.0 Guyline Blocks		
Item	Code	Comment
7.1 Appropriate		
Image	Image	Video
		



Item	Code	Comment
7.2 Cheek plates		
7.3 Spindle		
7.4 Sheaves		.5mm wear in all
7.5 Connection pins		
7.6 Shackles		
7.7 Safety strop		
Was there a safety critical issue? No		
<b>8.0 Tower</b>		
Item	Code	Comment
8.1 I.D. plate		
<b>Image</b>	<b>Image</b>	<b>Video</b>
		
8.2 Rope sizes		
<b>Image</b>	<b>Image</b>	<b>Video</b>
		
8.3 Visual alignment		
8.4 Dents, cracks		
8.5 Base plates		







Image	Image	Video
		
<p><b>8.6 Bosses, pins, knuckles</b></p>		
<p><b>8.7 Tower raising gear</b></p>	<p><i>clean ram</i></p>	
<p><b>8.8 Stabiliser ram/safety stop</b></p>		
Image	Image	Video
		
<p><b>8.9 Strawline/tagline mounts</b></p>		
Image	Image	Video
		
<p><b>8.10 Locking dogs</b></p>		

Image	Image	Video
		
<p>8.11 Telescope ram/rope/winch</p>		<p><i>clean ram down</i></p>
Image	Image	Video
		
<p>8.12 Guyring/lugs</p>		
Image	Image	Video
		
<p>8.13 Ladder</p>		
Image	Image	Video
		
<p>Was there a safety critical issue?</p>	<p>No</p>	





9.0 Tower Support Structure		
Item	Code	Comment
9.1 Frame/bosses		
Image	Image	Video
		
9.2 Levelling rams	N	
9.3 Ground support plate	N	
9.4 Chassis load path		
Image	Image	Video
		
9.5 Transport support frame		
Was there a safety critical issue?	No	
10.0 Guy Winches		
Item	Code	Comment
10.1 Drums & shafts		Blue 1mm white 2mm
Image	Image	Video
		
10.2 Drives		
10.3 Ratches & actuators		

Image	Image	Video
		
Item	Code	Comment
10.4 Guylines & anchors		
10.5 Guyline age (<7 years old)		Ropes new 3/2019
Was there a safety critical issue? No		
11.0 Swinger - gantry frame/rollers		
Item	Code	Comment
11.1 Gantry frame	N	
11.2 Pins and lugs	N	
11.3 Guyline fairlead	N	
11.4 Roller track, rollers & stops	N	
11.5 Roller frame	N	
11.6 Raising rope, anchor & winch	N	
11.7 Pendant rope (<2 years old)	N	
11.7 Pendant rope mounts	N	
Was there a safety critical issue?		
Specific details:		
12.0 Swinger - slew ring & carbody		
Item	Code	Comment
12.1 Drive & slew ring attachment	N	
12.2 Carbody cracks or damage	N	
Was there a safety critical issue? No		
Specific details:		

13.0 Safe Access		
Item	Code	Comment
13.1 Gangways & ladders (refer ACoP)		
13.2 Guarding (refer guidelines)		
Was there a safety critical issue?	No	
Specific details:		
14.0 Operator Protective Structure		
Item	Code	Comment
14.1 I D plate for FOPS & OPS		
Image	Image	Video
		
14.2 Structural integrity		
Was there a safety critical issue?	No	
Comments summary		
/////		
Were there any after market modifications?	Yes	
Details of modifications		
Image	Comments	
	New cab New hydraulic track base fitted	
Status of action items: <i>Closed</i>	Due Date:	Inspector sign: <i>PAZ</i>

## Appendix D

### Major inspection of tubular towers (spars)

Many of the tubular spars currently in service in NZ forests were designed for a maximum service life of 10 – 20 years. In particular, some of the North American spars built in the 1970's and 1980's were designed to be lighter than the previous generations of equipment to reduce on-highway transport weights. These spars were either built from thinner or higher tensile materials or both. In many cases, these spars will be approaching or have already exceeded their design life based on fatigue strength.

Practically, it is difficult for an inspector to assess remaining life, but if the spar has a history of repeated cracking and weld repairs being made this is a strong indicator that the design life has been exceeded.

It is not acceptable to continue to weld repair cracks on a spar (or other safety-critical component), even if they are not occurring in exactly the same location each time. A written recommendation should be made to the owner that an assessment by a CPEng is to be made before the next annual inspection or no further certificates can be issued from that time. The outcome of the CPEng assessment will likely be that the spar is to be re-manufactured, recovering whatever components can practicably be reused and have not been subjected to fatigue.

Smooth dents must not be of greater depth than the wall thickness of the tower material. It may be possible to draw smooth dents out satisfactorily. Localised induction heating is the preferred technique. Whatever method is used, the repair must be authorised/certified by a CPEng. Sharp-edged creases or repairs of other similar damage must be authorised/certified by a CPEng.

There is a second class of predictable spar failure where there may be no external signs, but it is known that internal components fail after a time followed closely by complete failure of the spar. At present, due to the construction of some of these tower types, it is not possible to obtain meaningful NDT results – without dismantling. If the fabricated assembly is dismantled the only sensible option is to rebuild with new components.

An example of a spar type known to be prone to hidden defects is the Madill 171 and 172. There have been several examples of spar head sections cracking right through in the vicinity of the guylines ring, but from the inside. Alert bulletins have been issued on this subject and the engineering safety inspector is advised to become familiar with them.

Guy winch spindles on Madill 071's are another example. These are prone to cracking which cannot be reliably detected without removing the spindles. Given the age of these machines, these checks should probably now be done annually.



This is not an exhaustive list of known failure types. As time goes by, more examples will become known. It is up to the industry to record and catalogue these and communicate this information to engineering safety inspectors. Similarly, engineering safety inspectors need to maintain their own library of alerts and bulletins to reference as needs arise.

It is very likely there will be a duty on the engineering safety inspector under impending plant regulations to report anything they may identify as a "type fault" to WorkSafe NZ in order that appropriate actions may be taken.

# Appendix E - Yarder Tower FICA APP User Guide

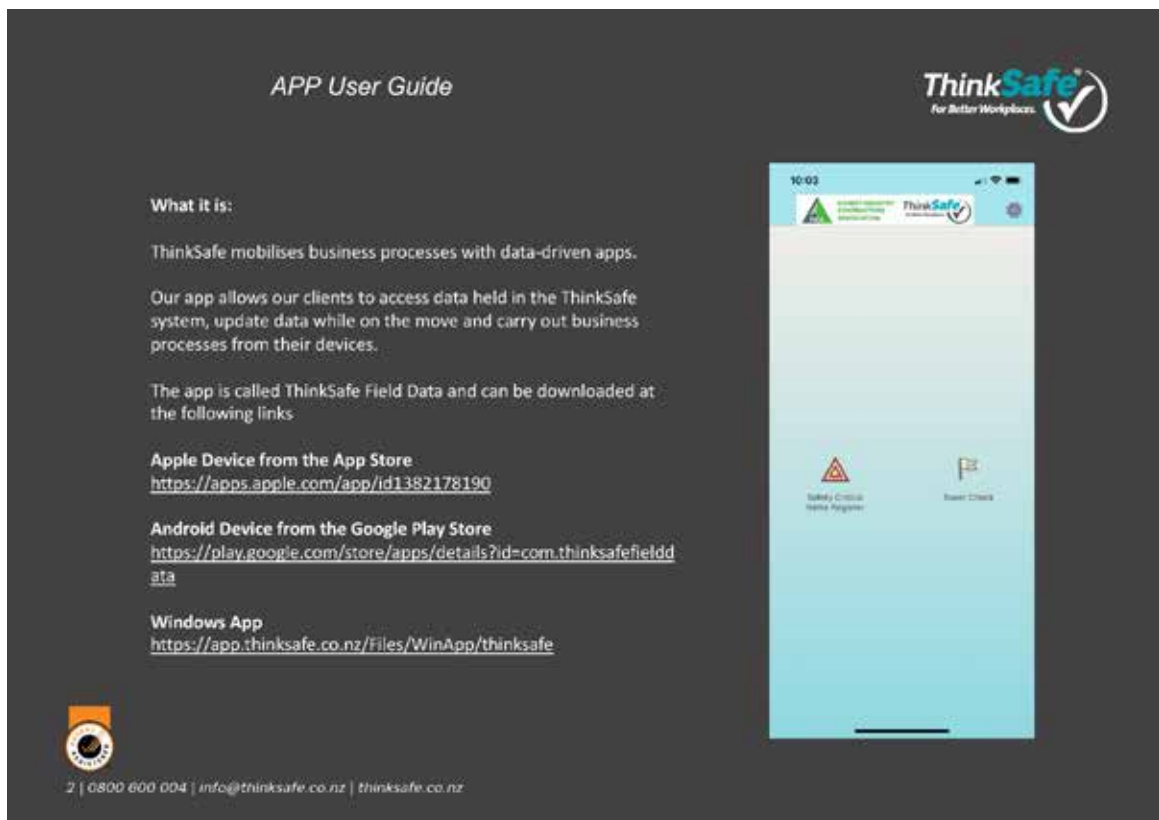



APP User Guide **ThinkSafe**  
For Better Workplaces. 

**Preparation:**

1. You will need an email address.
2. You will receive an email with the following subject message "Forestry Industry Contractors Association has invited you to use the ThinkSafe Field Data app".
3. Follow the instructions in the email to sign into the app. The home screen will look like this.









3 | 0800 600 004 | info@thinksafe.co.nz | thinksafe.co.nz

APP User Guide **ThinkSafe**  
For Better Workplaces. 



**The cogged wheel:**

1. you can change your password
2. force sync your data to the website
3. or log out





4 | 0800 600 004 | info@thinksafe.co.nz | thinksafe.co.nz

APP User Guide ThinkSafe  
For Better Workplaces



This stores the devices history of uploaded forms.





APP User Guide ThinkSafe  
For Better Workplaces



In the History area you can edit forms already completed.



APP User Guide



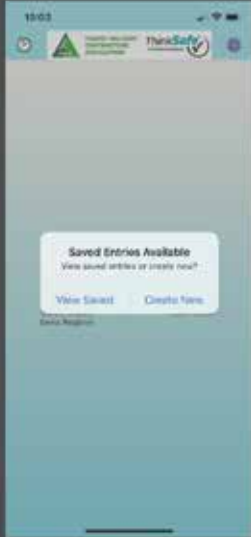

Partially finished forms can be saved and opened at a later time.



APP User Guide



The App works offline. Once your device connects to WIFI or cellular data the uploaded forms will automatically sync to the dashboard.



APP User Guide

ThinkSafe  
For Better Workplaces

The inspection report will be emailed to you directly on upload. Ready for you to share with the client.



ThinkSafe Support sent you a Tower Check

ThinkSafe Support sent you a Tower Check

Please see the file attached to this email.



ThinkSafe Support sent you a Tower Check



APP User Guide

ThinkSafe  
For Better Workplaces

If you need any assistance contact:  
[support@thinksafe.co.nz](mailto:support@thinksafe.co.nz)





***safetree***  <sup>TM</sup>